

FAST

FASTENING & ASSEMBLY SOLUTIONS AND TECHNOLOGY

Helicoil®

Precision design and engineering.

Specify the brand that is trusted
Worldwide.

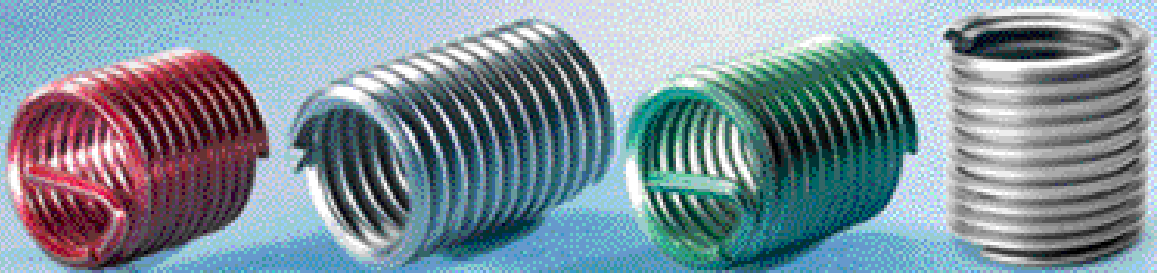

BÖLLHOFF

Armstrong Limited

Tel: 01482 591569 Email: info_bal@bollhoff.com

www.bollhoff-armstrong.co.uk

Experts in tape engineering



tesa® double sided tapes bond permanently and securely to a variety of substrates and include products with UL and TÜV approval. Our Heat Activated Films have a bond strength of up to 5 times that of normal pressure sensitive tapes and superior resistance to chemicals, temperature and ageing.



tesa® double sided tapes offer many advantages which can increase productivity, such as:

- no curing time before the next production stage.
- they can be converted into a die-cut format compatible with the components to which they are being applied.

With half our sales from products developed in the last 5 years, our R&D experts file an average of 70 patents every year keeping tesa as a leading supplier of new solutions to many industries.



Head Office
NewbyCom Ltd
Sanderum House
The Sanderum Centre
Oakley Road
Chinnor
Oxon OX39 4TW
Phone: 01844 352916
Fax: 0845 280 1587
Email: mark@fastmagazine.co.uk

Editor
Paul Gay
Phone: 07768 596492
Fax: 020 3004 2357
Email: editor@fastmagazine.co.uk

Publishing director
Mark Newby
Phone: 01844 352916
Fax: 0845 280 1587
Email: mark@fastmagazine.co.uk

Advertising sales
Harry Price
Phone: 01797 361188
Mobile: 07973 335616
Email: harry@fastmagazine.co.uk

Design
John Fisher
Phone: 01844 352916
Fax: 0845 280 1587

Production Department
Phone: 01844 352916

Reader Service
and Circulation Management
Capsule Publishing Services Ltd
Phone: 0845 602 7390
Fax: 0845 604 2327
Email: circulation@capsule-group.com

Printed by
Headley Brothers Ltd., using vegetable
based inks, supporting responsible use
of forest resources.

FAST makes no charge for the editorial
material which it publishes, unlike many
industrial and technical magazines. This
means that FAST's readers can be assured
that the information which appears on its
editorial pages has been selected by the
editor on the sole grounds that it will be of
interest. Make sure that any publication you
receive carries a similar statement of
editorial policy.

©2012 NewbyCom Limited
FAST (Fastening, Adhesives, Assembly &
Joining Technology) is a controlled
circulation journal published four times a
year. Readers who fulfil the publisher's
criteria and individually request the journal
will receive free copies. Subscriptions from
overseas readers or those who do not qualify
within the terms of the publisher's control
are £56 UK and £86 overseas.
Single copies £12.

No part of this publication may be reproduced, stored
in a retrieval system, or transmitted in any form or by
any means without the prior written permission of the
publisher. Photocopying or the reproduction without
the publisher's permission is in breach of copyright and
action will be taken where this occurs.

FAST January Comment

Keep only long term plans on the agenda



If ever Britain's manufacturing industry needed a New Year's present, it was the announcement earlier this month that Jaguar Land Rover is to double the size of its Halewood car plant, creating 1,500 new jobs and giving our struggling economy a major long term boost. This column could sometimes be accused of over optimism but in our view this news is another fine example of British manufacturing bringing our troubled economy back to some sort of stability.

Halewood is already one of the biggest car manufacturing facilities in the UK but has been running at full capacity producing the new Range Rover Evoque. Expanding the factory will let the company keep up with surging demand for its products. The news comes hard on the heels of good tidings released before Christmas relating to the premium car maker's plan to build an engine plant in Wolverhampton and redevelop its factory in Solihull. All in all, Jaguar Land Rover has hired thousands of new employees over the last 12 months to launch new models and keep up with the extraordinary demand for its products.

There is indeed much good news to consider of late. Apart from Jaguar Land Rover's Merseyside expansion, other UK based manufacturers including BMW and Toyota have announced plans to increase production at UK plants. Nissan and Honda have also reported good performance and long term commitment to the UK as they continue developing ecologically acceptable vehicles for the future.

BMW's British-based brands, Mini and Rolls Royce are both reported to be out performing their market and setting new sales records on the way. Again much of their production goes straight to export boosting the Treasury's coffers. Another premium brand, no longer British owned but most definitely British made is Bentley. The Crewe based manufacturer is experiencing demand back to pre-recession levels with strong sales growth in all its markets. Sales of Bentley cars in December were up a staggering 69% on the same month in 2010.

The UK government and the Bank of England have long been trumpeting the need to increase exports in an effort to rebalance the economy away from a reliance on a struggling consumer sector.

And the car industry has so far been a bright spot and although 2012 is being described by many as 'challenging' about 1.5million cars are expected to be built in Britain this year, up over 6% over 1 last year. By far the vast majority of those will be exported.

When it comes to export success, automotive is not alone amongst manufacturing sectors. Britain's aerospace industry is one of the biggest contributors of components and assemblies to Airbus, which delivered its 7000th aircraft last December. Airbus jetliners feature wings made at Broughton and many are powered by Rolls Royce engines made in Derby. Airbus Broughton opened a £400 million plant making carbon-fibre wings for the new A350 airliner last October.

For too long the UK economy has lost sight of where its heart is. The New Year's good news should remind us that manufacturing is still at the heart of the economy and also provides a key driver to the exports we will need in the long term.

If Britain's ambition to rebuild its manufacturing sector is to succeed, it cannot be fuelled by short term plans. And in the scale of things that means that planning for less than the next decade should not be considered. Short termism is certainly not on the agenda.

Jaguar Land Rover has plans to launch 40 new products over the next five years, which will lead to the creation of thousands of jobs in the long term. It must be remembered that it was only in 2009 that the company was forced to ask the Government for financial support as automotive sales slumped. But the extraordinary turnaround in fortunes since then has led to an annual research and development budget in excess of £1billion, which must be sustained into the long term.

R and D is a fundamental requirement for a stable and successful manufacturing industry. Companies like Jaguar Land Rover must be applauded, indeed emulated as such a powerful contributor, for their long term commitment to research, especially when the economy is struggling out of a recession.

Paul Gay, Editor
editor@fastmagazine.co.uk

FASTCONTENTS

REGULARS

06 FASTUPDATES

News and comment from the fastening and assembly industry

08 FASTUPDATE EXTRA

BAS Components was acquired by PSM International over a year ago and full integration is virtually complete

10 FASTCASE STUDY

Shaping the sporting wheelchairs of the future with modern materials and adhesives

12 FASTCASE STUDY

Performance fasteners give a clear view for BMW motor cyclists with vibration free fasteners

60 FASTPRODUCTS

FAST reviews the latest product releases in the fastening and assembly systems business

16 QUESTION AND ANSWER:



Over the last twenty years, the team at igus UK has been asked many questions regarding polymer bearings. Matthew Aldridge answers some of the more frequently asked ones including how polymer bearings are designed for a longer life

21 FASTCASE STUDY

In a novel piece of engineering design a fastener provides a convenient exhaust seal in cast component

46 FASTPRODUCTS

Seven pages of products reviewing the latest announcements in the fastening and assembly systems business



54 FASTQUIZ

£100 cash to be won for the correct answers of the FAST quiz. Sort out some tricky engineering trivia questions and win a cash prize



FASTCOVERSTORY

The Bollhoff Group, having consolidated its acquisition of Armstrong Precision Components, is pleased to announce that the company will now trade as Bollhoff Armstrong Limited with immediate effect. The same high quality HeliCoil product will continue to be manufactured, sold and supported in the UK by Bollhoff Armstrong from their established and enhanced location in Kingston upon Hull.

With the highest of technical credentials our military and aerospace approvals include Rolls Royce, Airbus and BAe, to name but a few. In design, manufacture and repair of soft threaded materials you can put your trust in HeliCoil wire thread inserts.

BOLLHOFF ARMSTRONG 01482 591569

FEATURES

18 FASTSHOW PREVIEW

We preview our forthcoming FAST and IASE spring shows being held for the first time in the North of England

26 How to:

Get into structural bonding
Are you missing out on the benefits?

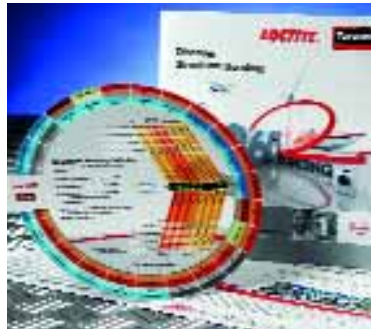

29 How to:

Bond dissimilar materials

By choosing the correct adhesive tape

30 How to:

Bond dissimilar materials . . . part two

Olympic security and rescue boats are bonded for rigidity using automated dispensing

32 How to:

Bond dissimilar materials . . . part three

One of the biggest challenges in bonding and sealing applications in the manufacturing industry is coping with dissimilar substrates. Our adhesives expert provides some practical solutions

34 How to:

Bond dissimilar materials . . . part four

Joining dissimilar materials can be quite a challenge, especially when traditional methods become impossible. FAST looks at the benefits of adhesive bonding and considers some problems which have to be overcome

39 Top Tip:

Sheet metal fastening and joining

Metal has a high surface energy which makes it easy for an adhesive to bond to it. It is also smooth, which means double sided tapes with any type of carrier can be used, increasing the choice of the most suitable tape for the intended application



41 Product review:

Threaded fasteners

Just what the designer ordered: the trilobal Flowform screw offers higher reliability compared to more traditional sheet metal joining methods

42 Product review:

Threaded fasteners . . . part two

The launch of screw family some 35 years ago revolutionised the application possibilities of thermoplastic assembly. FAST follows the development of this fastening family

44 Product review:

A different approach to fastener design

The concept of fixing a buttress screw into a helix thread is an interesting option in manufacturing design. FAST highlights some of the advantages the system has over conventional methods



FASTUPDATES

Buy and build strategy seals another deal

A Sussex company has continued its successful buy-and-build strategy after sealing a deal that strengthens its position in the global industrial fasteners market.

Heathfield-based **TFC**, which is one of Europe's leading suppliers of technical fasteners to industry and manufacturing, has acquired Engineering Services Fasteners (ESF), a Yorkshire company with a strong presence in the north of England. The £1.5 million deal is TFC's third acquisition in as many years.

The deal follows the acquisition last summer of Specialised Fastener Products and Cavalier Fasteners, the year before. Martin Clarke, joint managing director at TFC Europe commented: "The acquisition of ESF Ltd demonstrates our commitment to grow the business further and provide an extensive range of products and services to our customers."

Headquartered in Heathfield, and with operations also in Colchester, Walsall, Bochum in Germany and an office in Costa Rica, TFC supplies bespoke fasteners to industry. It also supplies more than 10,000 off-the-shelf fastening solutions, including panel, pipe and wire fasteners, springs and seals, to businesses in 24 countries around the world. As a company, TFC counts Bosch, Daimler AG, ZF Group, Bombardier Transportation Limited and Delphi Diesel

Systems Limited among its 3,000 international customers.

Following its acquisition in November, ESF has now been integrated into the TFC Group, becoming the UK's Northern centre for quality industrial threaded fasteners. Renamed TFC Engineering Services (ESF) is based in Keighley, Yorkshire, just north of the M62 corridor which connects the North West and North East of England, and specialises in the supply of quality industrial threaded fasteners. This move now means that TFC can offer its customers National fastener logistics coverage. TFC are now able to offer their full range of Direct Line Feed and Vendor Managed services locally to customers in the North.

ESF was established in the mid-seventies and developed into a broad based fastener and associated product distributor focused on the engineering industries of the North. ESF was the subject of an MBO in 2002 by the two vendors who took over the business from the founder. One of the vendors, Tony Bull, is now general manager of ESF within the TFC Group whilst John Wilson retired.

The ESF integration into the TFC Group means that turnover will approach £20m over the coming year with seven customer service centres throughout Europe.

TFC EUROPE 01435 866011



Springing into 2012 with an acquisition (left to right): Mathew Glentworth (banker) of NatWest; James Beaton (corporate partner) of Vertex Law; Martin Clarke of TFC Europe; Donald Maclennan (equity investor) of Foresight Group; and Geert Struyven (financier) of Crowe Clark Whitehill.

Give the manufacturing customers what they want

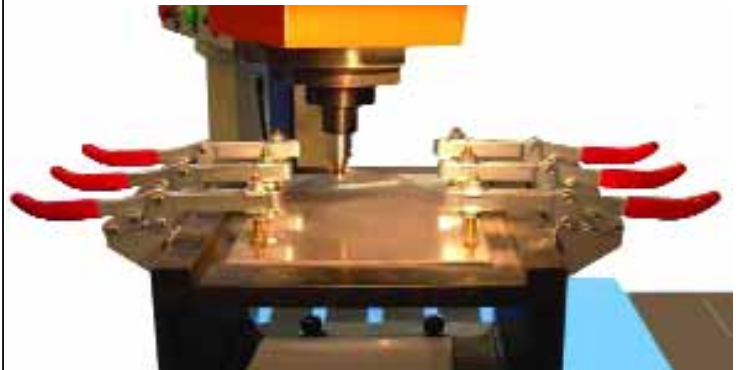

One of the country's leading small components manufacturers and distributors **Moss Express** carried out a survey to over 2,500 customers, last year, to gain a better insight into their views of the Moss Express brand, its products and service.

Customers in eight countries responded to the survey and voted Moss' large product range, next day delivery and its free sample try-before-you-buy service as key factors in making their purchasing decisions as well as rating its quality and knowledgeable customer service highly.

Managing director Scott Fawcett commented: "We operate in a very competitive market so it's crucial that we ensure that our focus never wavers from improving the customer experience. Finding out what our customers think, including opportunities for us to improve, is essential in keeping the business moving forward."

"We know that price is also a key factor so we remain very competitive but we have also learned that customers value having an informed person to talk to on the other end of the telephone," said Scott. "So we carry out a lot of product training with our teams and have knowledgeable product 'champions' available at all of our sites."

The survey showed that the majority of new customers research their product requirements online first, so Moss has just redesigned its website to make it more visually appealing and its vast range of products eas-

ier to find and order. The company's new product catalogue containing 14,000 products including 2,000 completely new lines is also available online or to order as hard copy.

The business's ambition is to double sales by 2020 and more than double the current 12,500 number of product lines. This involves further developing the e-commerce strategy as a greater part of the sales and marketing mix and improving the supply chain across the company's European network. "It's all about making it easier for the customer. Ultimately, I want Moss to be famous for its reliability and range, offering good quality, accessible, value-for-money products, underpinned by a remarkable service," said Fawcett.

● When the going gets tough and you need the ultimate production aid to prevent movement during manufacturing or any critical precision process, a high quality toggle clamp could be just the job. Moss Express has introduced a new range of toggle clamps that cover most industry applications. Available as vertical, horizontal, push-pull or plier products, the clamps are available either in zinc plated steel or high grade stainless steel. As with most Moss products, there's no minimum order requirement and all of the products are available for next day delivery.

Customers can also purchase toggle clamp accessories separately as clamp caps and spindles.

MOSS EXPRESS 01865 844479

Farewell EN 954-1, welcome the Machinery Safety Alliance

The **Machinery Safety Alliance**, which came into existence with the New Year, is a collaboration between Festo, Fortress Interlocks, Pilz Automation Technology, Troax, UK Engineering, and Werma and will take over where standard EN 954-1 left off. Each company in the new alliance will provide expertise from its own field to help machine builders and users make sense of safety, and to safeguard their productivity.

Until its withdrawal at the end of 2011, EN 954-1 provided presumption of conformity to the Machinery Directive 2006/42/EC. Now EN ISO 13849 will become the most widely used standard for the design, verification and validation of safety related parts of control systems. Part one of this new standard clearly states that electromechanical, non-electrical, complex electronic (programmable) and combinations of all these technologies are within its scope. Any component within the realms of these technologies can play a part in safety with the proviso that reliability data can be found for it.

In addition to components which contribute to functional safety, other components essential in machinery safety include guards, such as perimeter fences, sliding and hinge gates, and signalling devices, such as beacons and sounders.

"No single vendor or even integrator has all of these collective technologies, attendant technical support, manufacturing and application experience under one roof. UK industry needs an organisation which can make this collective know-how more readily accessible," said David Collier of Pilz Automation. "Machine safety compliance has opened up to more technologies with the slow introduction of EN ISO 13849, and there is still a learning curve for builders, users and even some component suppliers to go through with it. Added to

this it takes a great deal of experience and engineering insight to strike a balance between safety compliance, ergonomics, productivity, resistance to manipulation [overriding] and cost"

The Machinery Safety Alliance will begin in 2012 with the launch of a new web portal and a series of seminars at various venues around the UK. The focus of the seminars will be the real-world application of various safety technologies.

"We really think we can be stronger than the sum of our parts, and help to boost understanding of machinery safety in the UK" said Collier. "Not only do we offer diverse technology expertise, but a wide range of experience across all industry sectors."

MACHINERY SAFETY ALLIANCE
www.machinery-safety-alliance.co.uk



MACHINERY SAFETY ALLIANCE

The robot in a box targets the assembly line

Automation consultancy **GB Innomech** (Innomech) has introduced a low cost, flexible automated workcell concept that is designed to help automotive, aerospace and other sub-system manufacturers to improve their competitive edge by automating critical product assembly processes.

RoBox is literally a robot in a box and uses a fast, highly accurate robot that can be fully customised to carry out repetitive, labour-intensive or hazardous product assembly, adhesive dispensing, insert fitting or quality testing tasks. Typical applications include gluing and/or sealing components in water pumps, electrical enclosure boxes and other products. RoBox can be quickly and easily reconfigured

without its operators needing any specialist programming knowledge making it ideal for short runs and flexible production.

"Robot-based automation is widely accepted as one of the best ways for companies to save costs but some UK manufacturers have been reluctant to invest, compared with other developed nations because of outdated views about cost, set-up time and reliability," said David Beale, technical director at Innomech. "RoBox is being launched to address these concerns head on and is based on a new generation of high performance, industrial robots which are essentially general purpose tools that can be easily and inexpensively reprogrammed to handle multiple new tasks,"

Flexible automated workcells such as RoBox are also being increasingly brought in to help manufacturers protect their businesses from some significant costs that are frequently overlooked when calculating the full labour costs associated with manual manufacturing methods. For example: time lost from staff sickness or holidays, heating and lighting costs, the cost of personal protective clothing and the commercial risk of an occupational injury or litigation claim resulting from repetitive strain injury (RSI) and other musculoskeletal disorders.

A recent report from the European Agency for Safety and Health at Work further strengthens the case

INNOMECH 01353 667394

FAST Update brief

Norbar Torque Tools has announced the launch of its new sales and customer support operation in Mumbai, India, which opened its doors for business on 1st January 2012. This is the latest stage of the company's long-term strategic development and Norbar India will take its place in a global network of companies based in Australia, China, New Zealand, Singapore and the USA. The General Manager of Norbar Torque Tools India Pvt Ltd is Narendra Borse.

NORBAR TORQUE TOOLS
01295 270333

Bollhoff plans to show its latest innovative fasteners at Southern Manufacturing, 15 – 16 February 2012. The company will occupy stand U12 at the FIVE exhibition centre in Farnborough, Hants. Included in the company's display will be the Snaploc reusable push-on/pull-off fasteners and Flexitrol tolerance compensating fixings, which have delivered manufacturing cost savings for numerous customers. Demonstrations and product samples will be available on the stand.

BOLLHOFF FASTENINGS
01902 637161

Nelson Stud Welding UK has expanded its activities as part of the Doncasters Group. Other companies within the Fasteners Division are Specialty Bar Products Company, EBC Industries and Ferry Cap. All three companies have manufacturing facilities located in North America. Nelson Stud Welding UK can now offer products and services from its sister companies to customers within the U.K., Ireland and Scandinavia sales region.

NELSON STUD WELDING UK
01296 433500

FASTUPDATES

Business integration promises global growth



Managing director Lee Timbrell is looking forward to significant growth throughout 2012 stemming mainly from nominated and secured business

A year on from its acquisition by **PSM International**, BAS Components is looking forward to the full integration of its branded products, especially the Flangeform line, into the global markets served by its new parent.

Following the acquisition in December 2010, the business has operated largely autonomously. But now, a full integration of BAS into the PSM entity will provide a great opportunity to strengthen the two key ingredients of business performance, these being people and processes.

PSM was itself acquired in 2006 by a Swedish private equity firm EQT. Private equity firms are sometimes portrayed as corporate vultures that load their targets with debt, eliminate jobs and reward themselves with fat dividends before quickly exiting in search of the next deal. EQT Partners has, however, developed a softer reputation as a hands-on manager that nurtures its portfolio companies for long-term growth.

Following the purchase of PSM, other compatible acquisitions, such as BAS Components, followed.

During the summer of 2011, PSM International appointed a new chief executive, Paul DeMand who has been brought in to drive a global reorganisa-

tion. DeMand and his chief financial officer are based in Hong Kong and under his leadership, the key focus for the global business is sustainable and profitable growth in both established markets of North America, Europe and Asia through a combination of motivated direct technical sales staff, established and respected joint ventures and core distribution partners. To support its organic growth, PSM International is actively seeking to expand its route to market by engaging new partners in all three areas as well as exploring opportunities to enter key emerging markets.

To achieve its goals, PSM has vowed to work closely with design engineering as well as manufacturing and purchasing resources at the OEM and tier customers to ensure it maximises the utilisation of the group's global manufacturing facilities.

The company has a newly structured leadership team with defined regional managing directors who have full profit and loss responsibility for the region and are supported by local and global technical and management teams.

The European region is headed up by Lee Timbrell as managing director. He, incidentally, was running BAS Components before its acquisition and there-

fore has a broad insight into the reorganised group. "One of PSM's core competencies," suggested Timbrell, "is the technical strength of its people and product offering. The extensive product range of inserts for plastics (IFP), sheet metal fasteners (SMF), precision turned parts and cold forming technology combined with effective feed-system and in-die technology offers customers around the globe a real value proposition in fastening technology."

Timbrell believes that PSM is continually driving improvements in all areas of its business with some 'very encouraging'

results being experienced. R and D into new materials and fastening solutions remains a high priority and is headed up by global technical director Paul Martin who has decades of extensive and highly valued experience in the fastener field. The latest development is a range of aluminium inserts which provide 'light weight cost effective process savings' when compared to the more traditional brass inserts. "PSM is excited about its customers' reaction to this latest technology offering and rapid growth is expected across several market sectors including automotive," boasted Timbrell.

The global footprint of PSM is a key advantage for similarly structured OEM and tier customers who require local support for all their operation. "The business' future is looking very bright despite the general economic doom and gloom predictions emanating from the global media," claimed Timbrell. "Each PSM region is predicting significant growth throughout 2012 stemming mainly from nominated and secured business and the teams globally are motivated and focused to execute the opportunities that are being presented," Timbrell concluded.

PSM INTERNATIONAL
01902 407370

Flangeform is a high strength fastening solution for thin gauge applications, which has been designed by engineers to give quality and lasting performance. The product fits well into PSM International's offering, offering high strength attachment points, particularly in thin and pre-finished sheet materials and a stubborn resistance to bending moment. It provides a square flush-face on one side without distorting the component and there are no weld heat damage or fumes when the product is being applied.

Accuracy and positive positioning are assured and Flangeform comes into its own when used in mild steel, aluminium or pre-finished material. The system is especially suited to multiple insertion and automatic assembly in progression and transfer tooling and nuts are available from M4 to M12 with studs available in the M4 to M10 range.

www.psminternational.com

Perfect alignment – in line, every time.

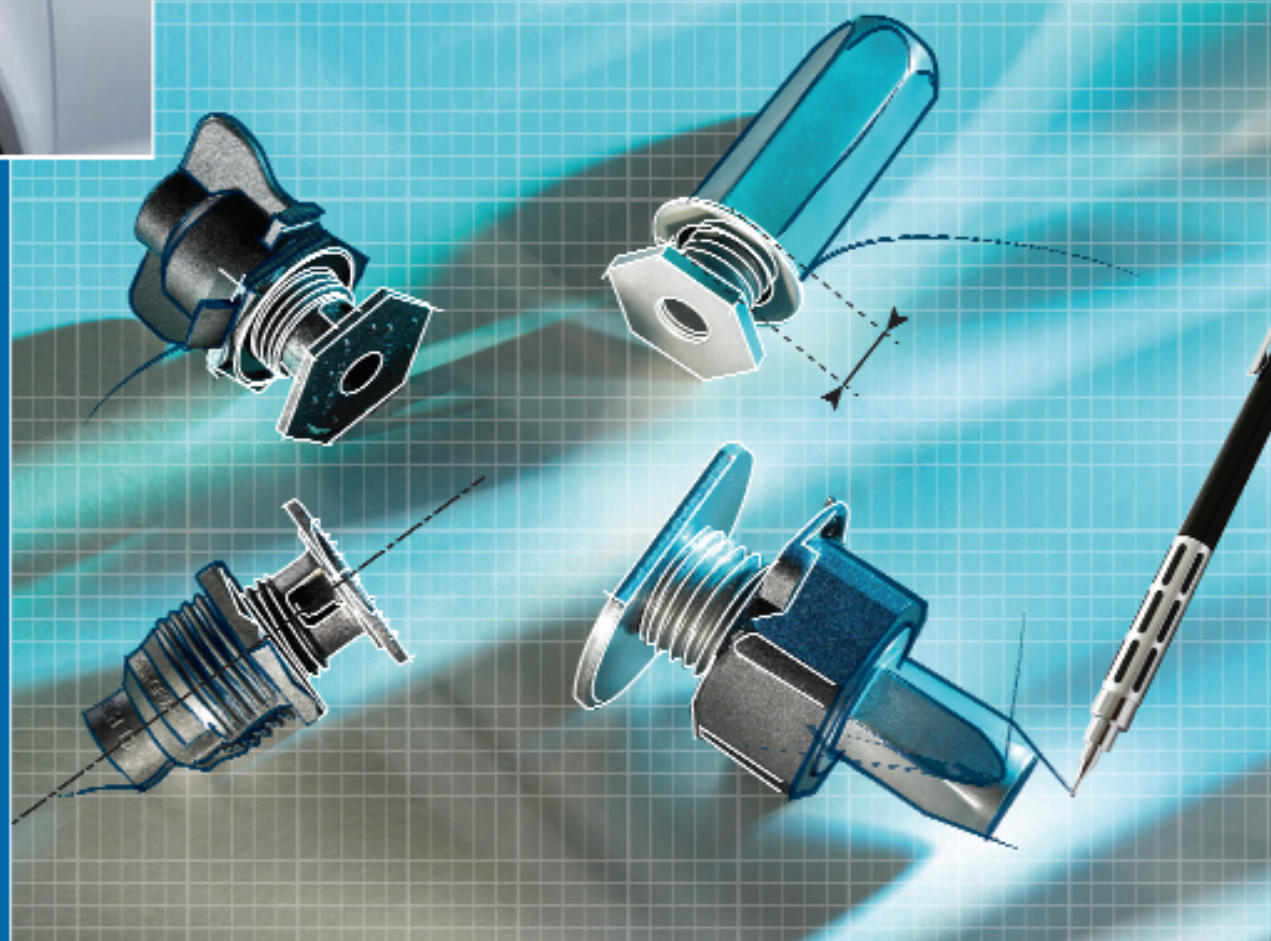

Meet gap engineering requirements, precisely, repeatedly with FLEXITOL stepless tolerance compensation fastener technology.

- Enhance quality
- Add flexibility to assembly operations
- Reduce manufacturing costs
- Lower the cost of outsourced components

BOLLHOFF

Joining together!

Call us today for details.

01902 637161

FASTCASE STUDY

Shaping the sporting wheelchairs of the future

Great Britain's wheelchair basketball team can be assured of optimum reliability in the wheelchairs in which they compete thanks to an adhesive solution from 3M

An issue facing Staffordshire-based wheelchair manufacturer RGK was the deformation of the bearing housings, which control the direction of the castor wheels, when they are welded to the main wheelchair frame. The company designs and engineers a range of state-of-the-art wheelchairs for both daily use and specialist sports, including basketball, tennis and sledge hockey. RGK designs robust yet lightweight quality products using titanium or steel bearing housings.

The welding process was on occasion causing the housing to become misshapen and exceed the tight manufacturing tolerances – as low as 0.02mm. This could potentially cause premature failure of the bearing which could itself become misshapen, resulting in substandard performance of the wheelchair. On these occasions, the housings had to be reworked, necessitating delays in production and additional cost.

The engineering team contacted 3M's Industrial Adhesives & Tapes Division to see if the com-



RGK sponsors the Great Britain wheelchair basketball team

pany's technical specialists could provide a suitable adhesive to bond the bearing housing into the frame.

3M proposed the use of a specialist adhesive, 3M Scotch-Weld EPX Adhesive DP460, to secure a machined part into the bearing

housing which would hold the bearings in place rather than relying on the main housing to do so – meaning any deformation as a result of the welding process was no longer an issue.

3M Scotch-Weld EPX Adhesive DP460 is a two-component gap filling epoxy adhesive, offering excellent heat and environmental resistance, which is designed for applications where toughness and high strength are required.

The use of this product has completely eliminated the need for rework plus the fact that the bearing performance is no longer affected by any deformation of the titanium or steel housing.

The new method is now being incorporated into RGK's range of wheelchairs for children and will also be used in the wheelchairs for Great Britain's wheelchair basketball team.

RGK is a sponsor of the Great Britain wheelchair basketball team and also supplied competi-

tive wheelchairs to a number of other international teams.

Mike Sheen, Design Engineer at RGK, commented: "The reworking of the tubes as a result of the welding process was something we were keen to eliminate. Meanwhile, we were keen to take every opportunity to optimise product reliability and the 3M solution has contributed significantly to that as bearing performance is not affected by any distortion of the housing shape caused by welding.

"The 3M product has proved ideal for this application and we are now in conversation with 3M about using other products such as tapes and threadlockers."

Mark Besant of 3M Industrial Adhesives & Tapes Division added: "This application once again shows the versatility of 3M in being able to supply a product to deliver a high-strength bond almost irrespective of the substrates involved."

3M 0870 60 800 50



A specialist adhesive secures a machined part into the bearing housing of the castor wheels

LOCTITE

Teroson

Discover Structural Bonding



Find your structural bonding solution with the interactive product selector on www.360bonding.com/uk

Class winner in all disciplines

Structural Bonding has become an integral part in today's industrial production processes and offers significant advantages compared to traditional fastening methods. Our entire expertise and product range provide suitable solutions for almost every application. And with our easy to use product selector you can find your structural bonding solution in the twinkling of an eye.

Find more on www.360bonding.com/uk



Henkel Excellence is our Passion

FASTCASE STUDY

Performance fasteners give a clear view for BMW motor cyclists

With top models of BMW motorcycles capable of achieving 175 bhp @ 9,250 rpm, blistering acceleration of 0-100kph in less than 3 seconds and top speeds up to 140 mph it is essential that riders have a clear view before overtaking. A shaky rear view mirror is definitely unwelcome and a potential danger.

Aiming to increase on-road safety and optimise the manufacturing procedures of its motorcycles BMW has adopted a demountable vibration-free fastener system to attach the wing mirrors to the bike. Snaploc, the high performance push-on/pull-off

fastening system is developed and manufactured by assembly specialist Böllhoff.

The Snaploc system minimises vibration of the mirror assembly and allows quick and easy snap-fit installation as well as disassembly for repair, replacement or servicing - all without the need for special tools.

The customised fastening solution comprises three Snaploc ball pins which are fitted to the metal frame of the motorcycle. These connect with three mating couplings which are press fitted into the engineering plastic mirror housing and held in place by



High performance BMW machines are capable of top speeds up to 140 mph by producing 175 bhp at 9,250 rpm from their 1293cc engines



The two component Snaploc fastener comprises a cup socket which has mated with a ball stud on the left and is shown detached on the right

an undercut. The ball pins, or studs, are injection over-moulded in glass filled nylon (PPA GF) engineering plastics around steel fasteners whose M6 threads are finished in a black Zn/Ni coating to enhance corrosion resistance. The receiving couplings are precision injection moulded in black EPDM - X: a grade of material that provides resistance to UV exposure and as well as the positive snap-fit and essential long term vibration absorption properties critical to this application.

Three basic designs of Snaploc couplings have been developed for plate fastenings, for mounting domes and fixing with adhesive. Different ball diameters accommodate a range of stress conditions while stud sizes and other physical dimensions can be varied to suit application requirements. Ball studs are injection over-moulded in engineering plastics around steel fasteners.

BOLLHOFF FASTENINGS
01902 637161

Helicoil manufacturer consolidates

The company formerly named Armstrong Precision Components will from now on trade from its existing location in Kingston upon Hull as Bollhoff Armstrong.

The company will continue to manufacture, sell and support the widest range of wire thread inserts available from a single source. These include the Classic Helicoil tanged insert, the Helicoil Plus insert with a patented reduced diameter first coil for ease of installation and the Helicoil Tangfree insert with no tang to remove.

Since becoming a part of the Bollhoff Group the company has invested heavily in new equipment and processes particularly in the areas of increased production capability and enhanced quality instrumentation. The company has enhanced and rationalised its range of thread repair solutions to provide a product price offering to suit all needs.

Professional Repair Kits, include a pre-winder installation tool together with full sized, full strength classic tanged inserts, with full traceability, for those highest of integrity requirements in aerospace and precision engineering.

Helicoil Plus Thread Repair kits with a reduced diameter first coil the insert is simply wound into the newly tapped hole to provide a full strength repair. Only the first coil is reduced in diameter, the remainder of the insert being full size providing full strength with ease of installation. Simplified tooling permits the use of cost effective power tools for greater productivity. Helicoil Eco-Kit, now supplied in a cost effective blister pack and including the ever popular shepherds crook installation tool for ease of use and simplicity.

BOLLHOFF ARMSTRONG
01482 591569

Jubilee®



BS 5315
KM06246



ISO 9001
FM00547



TUV
APPROVED

INTERNATIONALE
EISENWARENMESSE
KÖLN



4-7 March 2012

Hall: 4.1
Aisle: D
Stand: 061

T: +44 1634 281 200 E: sales@jubileeclips.co.uk
F: +44 1634 280 101 W: www.jubileeclips.co.uk

Concealed Hinge Perfection

- Three way adjustable without removing the door
- 4 knuckle high precision movement
- 40 to 300kg door weight options

PIVOTA®

BaSys

New Info. www.ba-sys.com



exclusively from

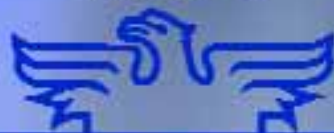

PHOENIX

by

COOKE BROTHERS

01922 740011

www.cookebrothers.co.uk
sales@cookebrothers.co.uk



NELSON Stud Welding

Stud Welding: the power of intelligence – Nelweld N4000



The Nelweld N4000

Intelligence is the key to the performance of the N4000. Controlled by a microprocessor, the weld cycle is constantly monitored, giving you the power to weld up to 22mm diameter studs with ease.

Nelson Stud Welding UK

47/49 Edison Road, Rabans Lane Industrial Estate,
Aylesbury, Buckinghamshire, HP19 8TE, UK
Tel: +44(0)1296 433500 Fax: +44(0)1296 487930
Email: enquiries@nelson-europe.co.uk
Or visit our web site: www.nelson-europe.co.uk



FASTUPDATES

Innovation and common sense brings productivity growth



tion, turning data capture into quantifiable savings in operational costs.

“A transformation is taking place in the way that we can use current wireless technology to capture event-changing data pushed to us very cheaply and in real time,” claimed managing director Martin Walder. “We have pioneered the industrialisation of GPRS for use in virtual networks and in combination with open web databases, to

monitor and control assets anywhere in the world. Our non-invasive systems, which are so easy to install, save money, save on maintenance and crucially, save on energy,” he added.

Failure prevention

The business has spent the last two years refining its patented technology to ensure the reliability of its ‘data push’. The results of this pioneering work are most evident in a busy International Airport, where the business was invited to develop a recovery plan on passenger sensitive equipment on lifts, passenger escalators and conveyors.

Hundreds of thousands of pounds have been saved on preventing catastrophic failure and proportionate savings have been demonstrated on energy savings, in maintenance costs and on material costs, parts renewals, together with significant cost avoidance on unnecessary call-outs and disruption to passenger services.

Global Sense calls its system ‘micro-intelligence’ precisely because it senses changes in the state of a component, such as a bearing in an escalator, and sends this micro data in real time, anywhere in the world, on any platform – including to a mobile phone-to inform decisions. “We do not burden our clients with big data in the way that legacy systems do,” claimed Roy Saunders, chairman of Global Sense. “Our analytics are incredibly precise and allow important decisions to be made on the fly, with the surety of reliable information, inexpensively mined and transferred. No one else can do this as reliably and as conveniently.”

Analytical tools

Exploiting data effectively requires simple and secure visualisation tools and Global Sense has developed a range of trademarked, analytical tools, such as Viewr and Archivr, to compli-

ment the Controlr (pictured). Together these programs focus on the hidden gems of information that, on the hover of a mouse, can alert customers to all manner of real and potential issues – even down to a light bulb failure.

Saunders again: “The idea of sensors embedded in products obviously leads to offerings such as preventative maintenance, but feedback like this can be used in every corner of a building, a utility like an airport, a shopping centre, a train line, and a manufacturing plant to prevent disruption, to improve productivity, to reduce costs, especially energy and to improve customer satisfaction.”

Global Sense has invested in a demonstration suite at its UK Head Office where clients can witness a bespoke and live demonstrations of the capability of their unique systems. Here visitors can get hands-on experience of the Global Sense products and witness exactly how the business can prepare you for exploiting micro data and pushing the benefits to the bottom line.

Global Sense claims that the system can do this for hundreds and not thousands of pounds, without the need to rely on old or to install new networks.

GLOBAL SENSE 07801 244920

gluegunsdirect.com[®]





VISIT US AT GLUEGUNSDIRECT.COM





Sheet Metal Fasteners



Inserts for plastics



Flangeform®



Tri-step®

FASTQ & A

Polymer bearings for a longer life

Over the last twenty years, the team at igus UK has been asked many questions regarding polymer bearings. Matthew Aldridge answers some of the more frequently asked ones

How do you make your bearings?

The standard method of manufacture is injection moulding, this process allows us to mass produce at a low cost, and involves very little manual labour. The polymer blends (called iglidur materials) that we use are exclusive to igus, developed in our own laboratory, and we also have our own toolmaking centre on site. This means we take care of all the production, from start to finish. In recent years, we have also introduced stock bar options for some of our materials, which allows igus polymer bearings to be machined as well as moulded.

What is an iglidur material?

The iglidur material is, in itself, a unique material, and we provide full material property sheets with every iglidur material, detailing the temperature and pressure limits, as well as other important technical data. The exact specific ingredients are only known to the scientists in our laboratory. In general terms, an iglidur material would consist of at least three components, a base polymer, blended with a solid lubricant and reinforced with a fibre. However, some iglidur materials have twelve separate components, so it can become extremely complex. This is another reason why we treat each compound as a material in its own right.

How readily available are igus bearings?

In a word – 'very'. We manufacture a standard range of parts, designed primarily to replace traditional metal based plain bearings, and we stock all of these as catalogue parts to allow quick delivery. Our aim is to deliver main catalogue items within 24 hours or same day. This standard range of parts starts at 1mm, and goes

all the way through to 150mm diameter. Also, the linear range of bearings, which includes rails, is cut to order and available ex stock.

I need a special part to my design, can you help?

We manufacture hundreds of tools for custom parts every year, so the answer is a resounding yes! If a customer wishes to utilise the advantages given by an igus bearing material in their own design, then we can make a special part to an agreed drawing.

Can you give advice on which bearing to use in a specific application?

All we need is data on the load, speed, shaft material and temperature. Then we can provide a detailed analysis of the application and give a precise calculation of the bearing life. This service is offered free of charge and is available for all bearing ranges manufactured by igus.

Can you help with the design of a part?

Both 3D and 2D CAD files are available for all igus parts, these can be downloaded from the CAD library on the igus website (www.igus.co.uk). Alternatively, the files can be emailed direct. Although the company does not offer a design facility, igus engineers will work with you on your design to help to arrive at the most suitable solution.

I only need a small quantity of parts, is this OK?

Absolutely! There is no minimum order for catalogue parts, so if you need just one part, then you only need buy one part. For special parts, there are two low volume options. Firstly igus can



Matthew Aldridge is a director of igus UK, which was founded in 1991 as a small office in Daventry, Northamptonshire. Today the company employs 66 people and is based in a 2,800 square feet industrial unit just 10 minutes away from the M1, enabling even quicker collection and delivery times. The UK subsidiary has also analysed new methods of packaging and recycling materials, which have led to quicker dispatch times and increased environmental friendliness.

The modern, spacious building also has ample car parking facilities and generous delivery vehicle access. The ground floor sales office is enclosed in floor to ceiling glass panels to maximise light levels and add to an open working atmosphere. All employees are equipped with the latest ergonomically designed work stations and have the same flat screen computer monitors and office chairs. The business is labour intensive by its bespoke nature. The shop floor area is divided by racks of components and each department can customise according to customer requirements. A special packing area is dedicated to bagging products up on a high volume basis with a customer's own barcodes. There is also a 100 metre long preparation area for long travel flexible cable configurations.

machine parts from stock bar to a customer drawing. Secondly, using a 3D CAD model from the customer, igus can manufacture a rapid tool, known as speedigus, which had no minimum order.

Do you have a quality system in place?

Yes, the manufacturing centre has both ISO 9001:2000 and the automotive standard TS16949. The igus UK facility has, in addition to ISO9001:2000 the environmental accreditation, ISO14001.

Can I get a sample?

Yes, if you need a sample of a standard catalogue part for technical evaluation, please contact us, we offer (and have always offered) free of charge samples.

Can you hold stock for us?

If a customer provides a blanket covering order for 12 months, then a buffer stock can be held to allow quick delivery. This service is offered free of charge to igus customers.

What is the cost of an igus bearing?

The cost varies considerably, literally from a couple of pence to thousands of pounds. If a customer is buying hundreds of thousands of 1mm diameter iglidur G bearings, then the price would be just a few pence, but if the customer needs a customised linear system, machined to a special drawing, and fitted with a motor, then



New methods of packaging and recycling materials have led to quicker dispatch times



the price can run into thousands. The goal of igus is to offer a saving of 25% over traditional bearings, while giving significant technical advantages, many customers are seeing savings in excess of this. All standard igus bearings have visible pricing on the igus website, www.igus.co.uk, where anyone can order parts directly online.

Why should a company buy from igus?



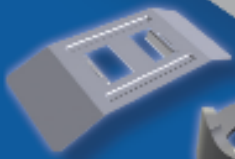

Well, in the end, it is the choice of the customer. What igus provides is an excellent product which will save money and improve performance, coupled with unparalleled customer service, full technical support, and excellent logistics. Our strategy is simple, we want to supply technically superior polymer bearings which save our customers money, summarised in our slogan "Plastics for Longer Life".

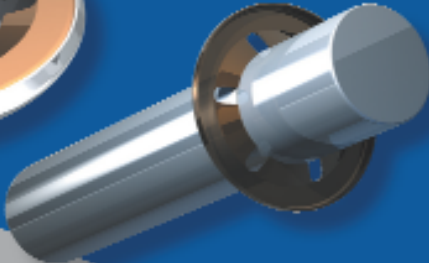
Starlock® PUSH-ON FASTENERS



Precision Pressings



www.bakfin.com

ISO/TS 16949:2009 ■ ISO9001:2008 ■ ISO14001:2004

Baker & Finemore Limited, 199 Newhall Street, Birmingham, B3 1SN, UK. Tel: +44 (0) 121 236 2347 Fax: +44 (0) 121 236 7224 e-mail: sales@bakfin.com

Fastener and adhesives shows head north



April in Harrogate this year will be an interesting month for design and production engineers based in the north of the country, especially those with a remit covering fasteners and adhesives. Paul Gay previews the FAST and IASE shows

The FAST and IASE exhibitions, which have found such great success in the Midlands, London and the Southwest, will visit Harrogate this Spring and will feature the industry's top suppliers of fasteners, fastening systems and adhesives. The Fastening & Assembly Solutions Show showcases everything good in mechanical fastening while IASE (Industrial Adhesives, Sealants & Encapsulants) does as good a job in the arena of industrial and engineering bonding.

Consequently engineers from Sheffield to Scotland will have their own fastening and assembly forum with expert exhibitors available to address their cost saving needs, quality enhancing

design opportunities and fresh supplier appraisals. The FAST & IASE Exhibitions have become known as a brilliant consulting forum and will now become a show for manufacturing industries in the North.

This year's FAST & IASE Exhibitions take place on April 26th 2012 at the Pavilions of Harrogate and as well as solving many of their fastening systems problems by meeting the industry's recognised technology experts, visitors will enjoy free parking and a complimentary bacon roll and brew providing they qualified as pre-registered visitors.

“New opening hours start one hour earlier, finish one hour earlier”

Organisers NewbyCom carefully chose the location for the show's northern debut. The criteria used demanded abundant free parking, easy to get to, out of town location.

The choice soon whittled down to the Great Yorkshire Showground, which ideal for buyers, specifiers and users in Scotland and all areas of the North. Managing director Mark Newby explained: “We wanted somewhere out of the centre of town – an easy to reach and convenient location, readily accessible with free parking. The site chosen at the Pavilions of Harrogate [at the Great Yorkshire Showground] has excellent facilities and I am sure will be ideal for both visitors and exhibitors. I'm expecting over 100 fastener and adhesive manufacturers to be represented at the shows,” Newby added.

The autumn event, held in October 2011 at the National Motorcycle Museum was an extremely busy and successful affair. Newby again: “The most recent event at Birmingham was our most successful since the shows were launched seven years ago, attracting more visitors than ever before. The comments of some of the exhibitors reveal just how good their experience was with us. One reason for this success was our ability as organisers to read market trends and action them to the benefit of visitors and exhibitors alike. For example, having identified that the need to be there was so strong amongst many visitors that they



FAST

FASTENING & ASSEMBLY SOLUTIONS AND TECHNOLOGY

exhibition

IASE

INDUSTRIAL ADHESIVES, SEALANTS & ENCAPSULANTS

exhibition

chose to attend the exhibitions before venturing into their offices, we offered an incentive for early starters by providing a bacon roll and cup of tea on arrival this year. As a result, between the 2009 events and this year's show we almost quadrupled the number of visitors attending in the first hour alone."

Exhibitors at Birmingham were clearly pleased with the quality of the audience and the standard of the other exhibitors. "The show was one of the best we have been to," said Peter Boote of Specialty Fasteners & Components.

Regular exhibitor Simon Dearing of Eurobond Adhesives suggested: "The

show for us was the best that we have participated in to date... good quality people, with good quality applications." And according to Danna Aerts of Nedschroef Fasteners: "For our company it was a very positive exhibition, it was a small investment for a more than satisfying outcome."

The organisers have noted that many visitors are under considerable time pressures and find it difficult to visit exhibitions at all, even if they have a genuine need. "So we are changing the opening hours at the Harrogate events from a 9.30am start to an 8.30am start and also closing an hour earlier at 2pm," commented Newby.

"We think that this will be of considerable benefit to visitors who are less than an hour away because it means they can visit the shows from 0830, spend the necessary time there and still be

"Good quality people, with good quality applications"

back in the office late morning armed with suitable ideas, inspiration and new contacts. Equally, visitors travelling any longer distances will invariably want to leave home early to miss traffic hotspots – opening an hour earlier at 0830 will benefit these travellers too because it will shorten their day and make life easier. As with our last event, visitors who pre-register in advance may



The last exhibition in Birmingham was extremely busy and well received

claim a free bacon roll and brew on arrival anytime between 0830 and 1300 on the day."

This is the first time that a dedicated fastening, adhesives and assembly event has taken place this far North in the UK and it provides an excellent opportunity for buyers, specifiers and users across Scotland and Northern England to embrace the latest developments and new products in the field, as well as discovering new suppliers.

Cost reduction and improved product quality are high on the agenda of FAST & IASE visitors and every survey the organisers have undertaken have shown that more than 96% of visitors achieved what they were hoping to as a result of their time at the shows.

To be amongst the first to see, discuss and evaluate everything new – including methods, products, practices and suppliers in fastening, adhesives and assembly – simply go to the exhibition websites and pre-register now.

Entry to FAST & IASE exhibitions is free. One registration provides a badge valid for both events and pre-registration can be done at either www.fastenerexhibition.com or at www.adhesives-show.com

PRECISION ENGINEERED COMPONENTS & FASTENERS



First Components Limited

First Components supply machined parts and assemblies using the latest CNC technology. As a component manufacturer we are experienced in turnkey projects, have sub contract expertise and have the experience to project manage contracts from conception to completion.

Savigny Oddie Limited

Savigny Oddie manufacture and supply a comprehensive range of quick release fasteners and associated hardware which include the Oddie fastener, latches, hinges and handles etc. Our modern equipped manufacturing facility allows us to design, prototype and deliver product to customer specification and timeframes.



Services include:

- Design
- Toolmaking
- Wire Erosion
- CNC Turning
- CNC Milling
- Wire Cutting and Forming
- Laser Cutting
- Pressbrake
- Power Presses
- Fabrication
- Metal Finishing
- Assembly



**FIRST
COMPONENTS
LIMITED**

**SAVIGNY
ODDIE LIMITED**

Wallows Industrial Estate, Wallows Road, Brierley Hill, West Midlands DY5 1QA

Tel: +44 (0)1384 262068
Fax: +44 (0)1384 482383
Email: Info@firstcomponents.co.uk
www.firstcomponents.co.uk

Tel: +44 (0)1384 481598
Fax: +44 (0)1384 482383
Email: Info@oddiefasteners.co.uk
www.savigny-oddie.co.uk

CASE STUDY

Fastener provides easy exhaust seal in cast component

A first tier supplier to the global heavy goods vehicle manufacturing industry is manufacturing a component where the body is produced via the aluminium zinc die-cast process. An element of this process is the need within the component to have a means of exhausting air and gases out of the cavity during the pouring of the molten metal. This is achieved by creating a small boss on the component with the

exhaust hole passing through the centre.

This exhaust feature needs to be closed and sealed after the moulding is complete; the novel way that they achieved this was by machining a small counter-bore within the boss and then introducing a ball bearing which is then staked in position.

Baker & Finnemore, which recently celebrated 100 years since the incorporation of the

business, has been established since 1850 and can offer a wealth of mechanical engineering experience to its new customers. Following an enquiry from such a customer, the design department got to work on a new capped product with a specific feature of a hole in the cap.

The problem that had to be overcome was to ensure the staking process was foolproof. The engineers produced a special

capped part complete with a hole so that the Starlock fastener simply pushes over a boss inside the component thus trapping a ball bearing which seals the exhaust port. The hole in the cap becomes an added safety feature so that the assembly can be viewed to ensure that the ball bearing is in-situ.

BAKER & FINNEMORE
0121 236 2347

Sealing is achieved by machining a small counter-bore within the boss and then introducing a ball bearing which is then staked in position

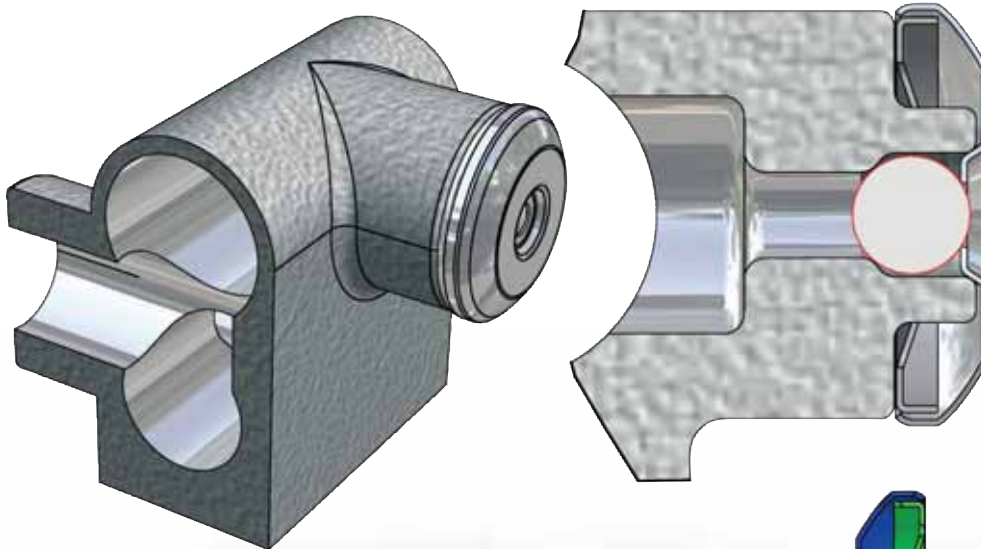

Birmingham based Baker & Finnemore manufactures the Starlock push-on fastener, a product designed for use where a quick, permanent, cost effective and efficient means of assembly is required to retain plain shafts of steel, non-ferrous and plastic materials. They eliminate costly threading and grooving operations assist rapid assembly and once in position they cannot be removed without destruction.

The company also manufactures custom precision pressings made from spring steel, other ferrous and non-ferrous materials. The company attained the ISO/TS16949 standard during 2010 and is also accredited to ISO 9001:2008 and ISO14001:2004.



Bonding agent boasts bounce but no hazard

Following a successful 25-year relationship with Coleshill-based Sil-Mid, Huntsman Advanced Materials has made available its latest flexible adhesive system through this distributor channel

Huntsman Advanced Materials developed a new silyl-terminated polymers adhesive system to meet the requirement for genuine elasticity in bonding applications. In contrast to the high-strength epoxy and methacrylate-based systems, this one-component adhesive offers outstanding flexibility and elastic recovery combined with high adhesion properties due to its silane modification.

These properties are combined with good paint ability, weather resistance and outdoor durability, as well as ease of application and they are free of any isocyanates and do not carry any hazard symbols.

They are multi-purpose adhesives for bonding a wide range of substrates, with general industrial applications such as elastic bonding in ship and boat building or solar energy. Core markets include bus, truck, rail and special vehicles such as caravans and camping mobiles.

Following Sil-Mid's involvement in the aviation industry, the company is now diversifying into new markets and the ambition as part of a strategic intent is to expand its market share by supplying the whole of the transportation sector.

Sil-Mid has been established for over



This one-component adhesive offers outstanding flexibility before eventual failure

31 years and is a dedicated specialist global distributor of adhesives, sealants, lubricants, silicones and cleaning compounds. Providing a single source and point of contact with an immediate supply capability, the company offers a full and extensive range of products for maintenance, manufacture, production and repair and can source and supply over 14,000 products globally, in partnership with over 400 suppliers.

"Our partnership with Huntsman Advanced Materials is one that we trust and we value our relationship which has been built over an extensive period. Their products will always feature within our portfolio, we have to continually offer strong and durable products," claimed managing director Gary Marriner.

"Sil-Mid Ltd is at a turning point in its future where focussed and planned change is necessary and desirable in our journey forward," added Marriner. "Today we are driving that change through a new path, aimed at increasing our market share, reinforcing our aviation success and expanding our future commitment to the whole of the transportation sector."

To substantiate this, the company has been awarded

AS9120 accreditation, the quality management system for aerospace. Including the requirements of ISO 9001 the standard defines in excess of 100 additional quality requirements for aerospace-industry distributors. The majority of aerospace manufacturers now expect their suppliers to be AS-certified.

The standard is designed for organisations who deal with the stocking and distribution of aerospace components and materials. Specific requirements for chain of custody, controlling issues, the availability of records, identification and traceability of sources of supply have been added to highlight the areas of importance to the aerospace industry such as safety critical and reliable products.

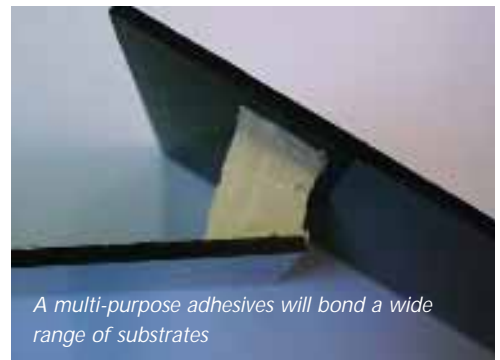

A multi-purpose adhesives will bond a wide range of substrates

When dealing with an organisation which aligns itself to AS9120, customers profit from improved quality and efficiency as well as receiving world class customer service.

Sil-Mid offers a 24/7 online ordering facility that enables customers, who do not have the time to source product personally but want rapid procurement, to drive out unnecessary cost and increase productivity. Araldite 2060 (white) and Araldite 2061 (black) adhesives are available, next day delivery, from www.silmid.com at a cost of £5.17 per 290ml cartridge.

SIL-MID 01675 432 850

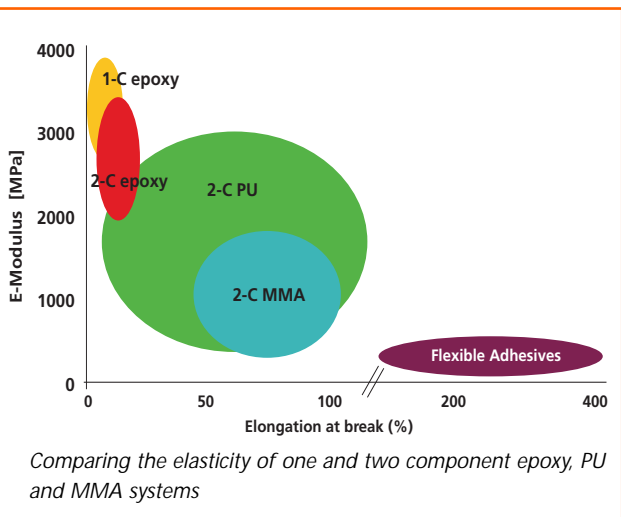

Comparing the elasticity of one and two component epoxy, PU and MMA systems

HI-GRIP®



HIGH PERFORMANCE HOSE CLIPS TO BS5315

HI-GRIP

- MILD STEEL, BRIGHT ZINC PLATED & PASSIVATED
- THE HIGHEST QUALITY CLIP AVAILABLE TODAY
- ROUND EDGE BAND FOR BEST HOSE PROTECTION

HI-GRIP STAINLESS

- ALL PARTS MADE FROM 16/8 STAINLESS STEEL
- LLOYD'S REGISTER TYPE APPROVAL
- FIRST CHOICE FOR THE MARINE INDUSTRY

HI-GRIP WING SCREW ZINC PLATED AND STAINLESS STEEL RANGES

- IDEAL FOR FREQUENTLY REMOVED HOSES IN
 - LABORATORY
 - INDUSTRY
 - GARDEN
 - HOME
- SUPER FREE RUNNING & EXCELLENT SEALING

HI-GRIP FLEXIBLE SCREWDRIVER

- MAKES FITTING EASIER IN AWKWARD PLACES
- WILL NOT SLIP OFF SCREWHEAD



JCS HI-TORQUE LTD

CHILTON INDUSTRIAL ESTATE SUDBURY
SUFFOLK • CO10 2YH • ENGLAND

TEL (DIRECT SALES) +44 (0) 1787 888031

TEL (SWITCHBOARD) +44 (0) 1787 376212

FAX +44 (0) 1787 880633

E-MAIL: sales@jeshi-torque.co.uk

WEBSITE: www.jeshi-torque.co.uk



NUTS, BOLTS, COTTER PINS OR TOOLS NEEDED

INTRODUCING SLIC PIN™ THE SELF-LOCKING IMPLANTED COTTER

IT'S
LIKE HAVING
A PIN AND A
COTTER ALL
IN ONE!



Protected by
patent no.
6,872,039

The quick, easy and secure SLIC Pin incorporates a unique, self-locking, implanted cotter and is ideal for: • blind holes • wherever cotter pin access is limited • automated assembly • and much, much more

1-45

More information from
our technical sales team:
01803 868677
or visit our website:
www.specialty-fasteners.co.uk

SE SPECIALTY FASTENERS & COMPONENTS

Seymour Wharf, Steamer Quay Road, Totnes, Devon TQ9 5AL

star

FASTENERS

www.starfasteners.co.uk

THE UK'S LARGEST DISTRIBUTOR OF



• **HUCK®
FASTENERS**

• **QUALITY
RIVETS**

• **THREADED
INSERTS**

• **TOOLING**

- Sales
- Hire
- Repair



Unit 3, Gallows Industrial Estate,
Furnace Road, Ilkeston,
Derbyshire DE7 5EP
T: 0115 932 4939 F: 0115 944 1278
E: sales@starfasteners.co.uk





Increase Your Profit Through Precise Piece Counting

Even a small level of overfilling can have a major influence on the profitability of your production operation.

METTLER TOLEDO's piece counting solutions can help you deal with piece weight deviation, environmental influences and scale accuracy within your manufacturing process.

Use our online quick selector guide or download our free overfilling calculator, piece counting guide and case studies.

► www.mt.com/count

Mettler-Toledo Ltd
Call: 0116 234 5095
Email: enquire.mtuk@mt.com



METTLER TOLEDO

view on-line store

www.associatedspring.co.uk

SPRINGS

if you have a problem we'll have the solution

01386 443366

all types and sizes in stock

BARNES GROUP INC

PROTEX®

Over-centre latches

- Buy direct on-line from the manufacturer
- Mild steel zinc plated or stainless steel
- Huge selection available on-line
- £20 minimum order

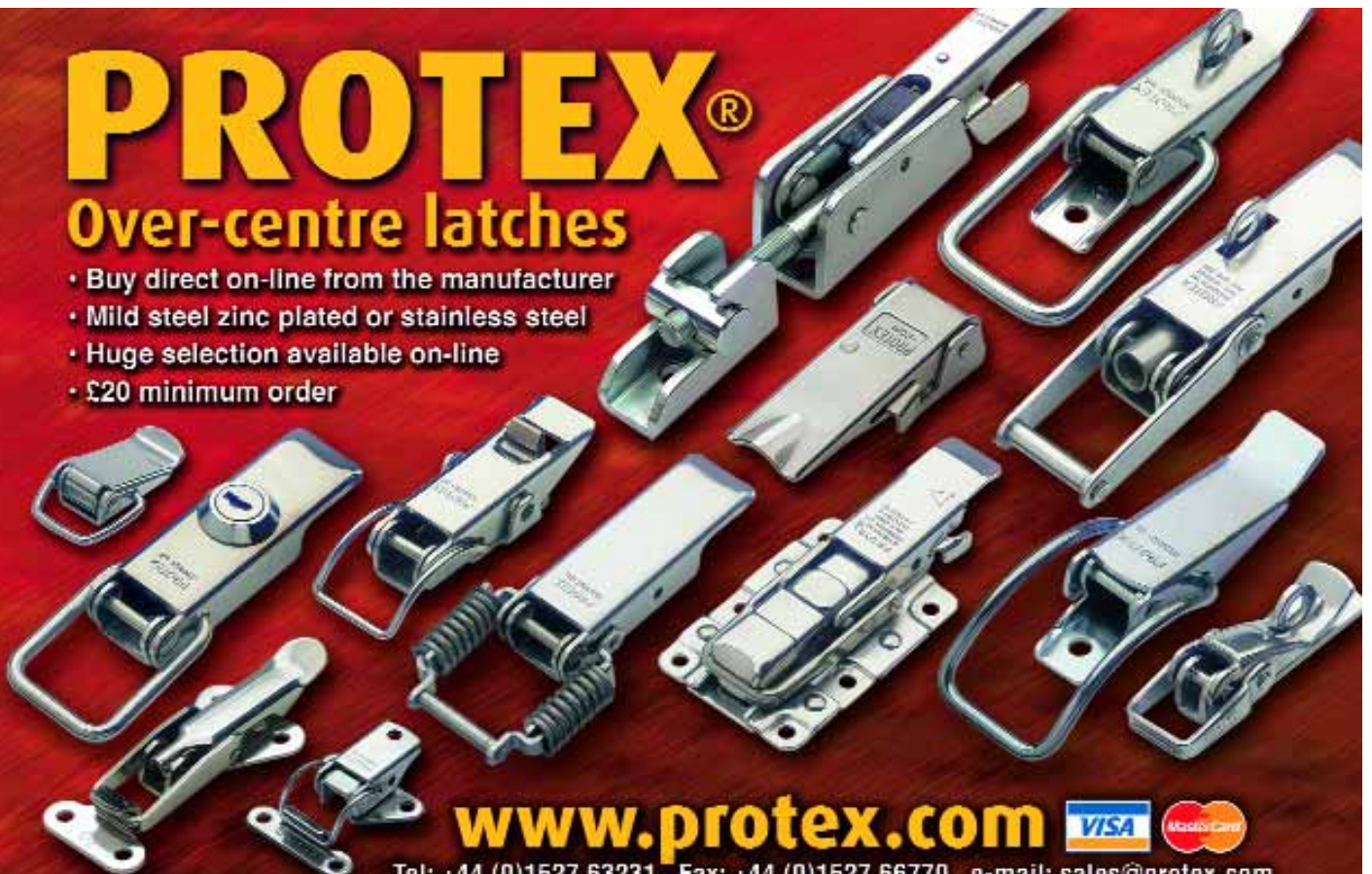

www.protex.com



Tel: +44 (0)1527 63231 Fax: +44 (0)1527 66770 e-mail: sales@protex.com

Fastening concept sees the light

A recently developed technique involving mechanical and adhesive fastening is making inroads into automotive and white goods industries. Paul Gay explains how it can be applied

Composite material, carbon fibre and special alloys show many advantages in the fabrication industries. They are generally light in weight and extremely strong and therefore very applicable to the automotive sector but fabricating panels into shells using traditional fastening techniques presents a real challenge.

Techniques like stud welding or pressing are clearly not practical when joining composite sheets. Drill and tap operations are time consuming and as engineers found when fabricating the McClaren Mercedes SLR, using a substantial number of Rivnut fastenings which all have to be drilled and positioned. "Good for a €400 000 supercar but not for mass production," explained Andy Witts, managing director of Böllhoff Fastenings.

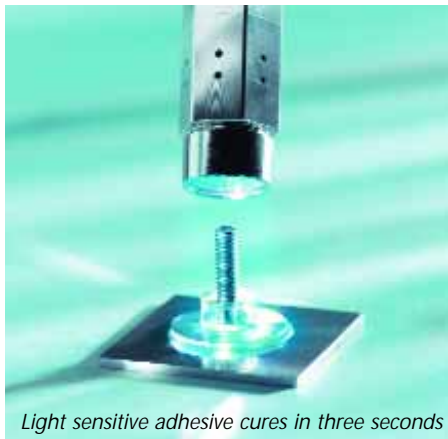

Light sensitive adhesive cures in three seconds

When it comes to higher volumes, manufacturers can benefit from a faster way of assembling panels. And this is where Böllhoff's Onsert concept comes in. A high profile German manufacturer is producing a city car with a body shell entirely of carbon fibre and two dozen studs are used on each unit to assemble the shell. Böllhoff has collaborated with US intelligent bonding specialist DELO Industrial Adhesives to produce the Onsert, which in concept is a threaded

fastener encapsulated in a transparent cap which is then bonded to the assembly using a light curing acrylate adhesive at room temperature. The bond is made in just three seconds; and in that time the joint has totally polymerised. The adhesive is sensitive only to blue light at a wavelength of 400nm, hence the transparent cap on the stud. Once Onsert has been positioned, the light source is switched on for five seconds to guarantee the bond and provide a very short production cycle.

Studs are placed by an assembly robot fitted with a Böllhoff patented gripper head with a circular LED light collar which matched the profile of the moulded cap of the stud. Once fed to the head, a doser applies a blob of adhesive to the stud and the fastener is positioned. A quick burst of blue light completes the operation.

The equivalent operation using more traditional methods would be much cheaper but would involve a drilling operation followed by a fixing stage possible followed by a further fixing to finish the job. Time is an important consideration on the production line.

A washing machine manufacturer designed a model with a screen printed glass panel with LED displays behind. The panel had to be demountable for future servicing requirements but aesthetic considerations meant that any fastening arrangement had to remain unobtrusive through the front panel.

The solution turned out to be a translucent polymer post fitted with a brass insert adhered to the glass panel and fixed from the rear. The panels are robotically placed at more than 1000 per day proving again that time is a key factor.

"Onsert is not a product, it's a concept," suggested Witts. Many fasteners will be applied using light curing adhesives in the future. Böllhoff's Snaplock has been applied in this way. This ball pin

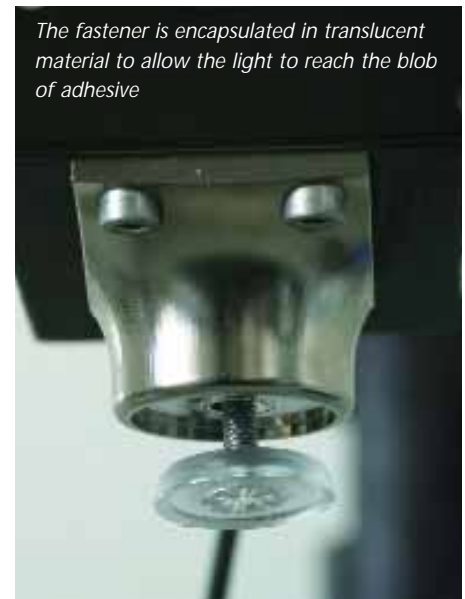

The fastener is encapsulated in translucent material to allow the light to reach the blob of adhesive

and coupling fastener is being used to fix engine covers in the under bonnet environment. Here a translucent nest, like a collar, slips over the coupling which then sticks to the fan cover when shown blue light.

As is evident, Onsert has gone through its prototype stage and will go into full production during 2012. Fully automated companies making upwards of 100,000 fastenings per week will be using robots. But for those involved in medium sized manufacturing, around the 10,000 fastenings per week level may well opt for the hand held which is being industrialised for the SME this year. The tool has a light source in the form of a collar which fits around the fastener being placed. Once adhesive has been applied, the operator presses the fastener into place and in doing so energises the light source for the prescribed time to cure the bond.

There are of course competitors to this form of fixing on the market but most have a curing time of around 24 hours which is simply too long for the production environment. These products find themselves largely in the DIY market.

BÖLLHOFF FASTENINGS 01902 637161

HOW TO: GET INTO STRUCTURAL BONDING

Structural bonding – are you missing out on the benefits?

The performance benefits of adhesive bonding in manufacturing are well documented and there are some persuasive arguments in favour of its adoption

The quality and performance of a system or product can be substantially improved by the inclusion of structural bonding in its manufacturing and build process, either as an alternative to mechanical fixing or to complement it.

Why then, with these benefits in the offing, is structural bonding not more widely adopted? To a large extent this is a problem of perception so before we consider the different technologies within structural bonding lets first address some of common reasons for resistance.



The vibration in a garage door mechanism can be minimised by adopting structural bonding

Turning to a bonding solution is often a last resort because engineers either don't trust adhesives or they are not familiar with their use. This view is completely at odds with the fact that we all feel perfectly safe and protected behind our cars' bonded windscreens. And these are structures exposed to enormous loads particularly if the car is involved in an accident.

Of course the difference is how the join is created. By comparison with a

rivet, bolt or spot weld, a single adhesive spot bond can't compete on force per unit area. However with a correctly designed joint, the greater contact area created with structural bonding spreads the load and creates a much stronger joint than could be achieved even with multiple mechanical fastenings or welded joints.

Whilst an even transfer of forces can be achieved to some extent with soldering and brazing, it is not true of welding, rivets or threaded fasteners. All these methods damage the material structure creating potential for fatigue over time. Furthermore structural bonding is as suitable for joining a wide range of dissimilar materials.

Traditional fastening methods also exacerbate the problems of vibration and tension. By switching to bonding its plated steel air conditioning units, one HVAC manufacturer has virtually eliminated the resonance that occurred when its units were in operation. Bonding has excellent sound deadening properties. As a result the company not only improved its products' performance but also substantially boosted their appearance as the solution requires no additional finishing to improve aesthetics. And that saves production costs too.

An overall reduction in weight is also provided with structural bonding as is corrosion resistance and the creation of a completely watertight joint; the bond completely seals the joint against the ingress of water and debris.

Other forms of fastening certainly have their part to play for applications

that are not better suited to structural bonding. A combination of both techniques is ideal for many tasks. A coach manufacturer, for example, used rivets in the corners of their roof panels for fixing after the application of adhesive. In this way the assembly can be moved immediately after bonding as the rivets hold the surfaces together during cure time.

This is one way of accommodating the cure time needed with most adhesives other than the instant-bond products. Companies considering incorporating structural bonding may feel cure time introduces downtime in the manufacturing process but it is often just a question of re-thinking process flow. With faster curing adhesives the time to fixture strength can often be accommodated in the production line. If a slow curing adhesive has to be used maybe bonding could be the last process undertaken on the working day so the structure is fully cured for easy handling the following morning.

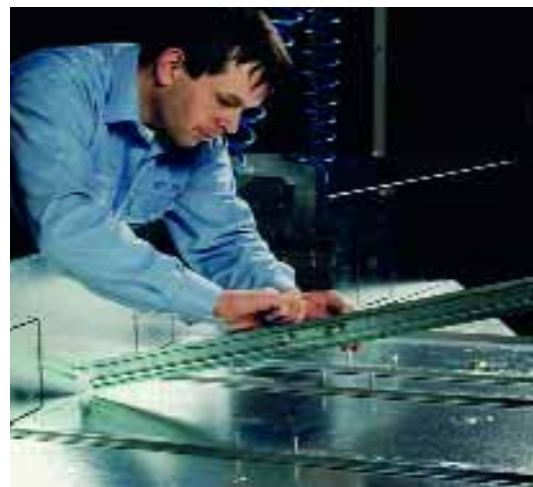

By switching to bonding its plated steel air conditioning units, one HVAC manufacturer has virtually eliminated operational resonance

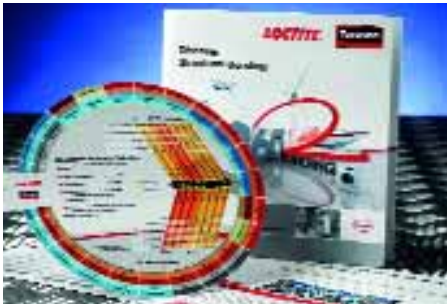

A three-disc structural bonding selector is available from www.360bonding.com

In virtually all cases the quality and performance benefits achievable with structural bonding far outweigh the arguments for other methods in isolation.

Another common misconception of structural bonding is that it's messy. In fact there is no reason for this if the correct amount of adhesive is applied in the right place. The important thing here is for your product supplier to suggest the optimum method of application; this could involve dispensing straight from the bottle or by using a manual or automatic dispensing system.

You should take time to investigate the

credentials of your structural bonding supplier. There are many products on the market to choose from, each with different characteristics and properties. So selecting the most appropriate solution for a given application requires expert evaluation. This will ensure that not only does the adhesive provide the performance needed but also that it is applied correctly for maximum cost and time efficiency.

Ask about the company's breadth of product range and applications experience, both from a chemistry and system engineering perspective. Talk to its customers if you can. The overriding message here is work in partnership with the experts to ensure you have the right solution for you. All too often the user's incorrect choice of product can lead to structural bonding being ruled out completely when all that was needed was expert advice.

Consideration must also be given to adhesive joint design to achieve the most uniform stress distribution. Again, your adhesive supplier should be able to help

with this. Bonded joints accommodate tensile and shear loads but peel and cleavage forces should certainly be avoided as far as possible.

Having optimised the joint design for bonding the next step is to select the most appropriate adhesive technology. There are many options here, each having its own performance characteristics and your supplier will be able to help you select the best for your needs.

To give manufacturers an idea of which type of adhesive product to choose for their application, technology leader Henkel has produced a neat, three-disc structural bonding selector. It allows the user to marry up the materials to be joined on the bottom and middle discs, leaving the top disc to reveal the most appropriate adhesive against criteria such as chemical resistance, load transmission, gap filling, large surfaces and elasticity. The selector is available from www.360bonding.com – the website dedicated to the Loctite and Teroson structural bonding products from Henkel.

HENKEL LOCTITE ADHESIVES 01442 278000



3M Tapes & Adhesives Online
FREE Technical Advice



www.vikingtapes.co.uk

the 3M specialists
01535 610373

bigHead[®]

Secure fasteners for Composites

Embedded or surface bonded, bigHead fasteners save time.



Visit our website:

www.bighead.co.uk

+44 (0)1202 574 601



**A PRECISION PRELOAD
LOCKING FEMALE
THREAD FORM THAT IS
EXCEPTIONALLY
RESISTANT TO VIBRATION**

Aerospace

Automotive

Oil & Gas

Construction

Heavy Truck

Marine

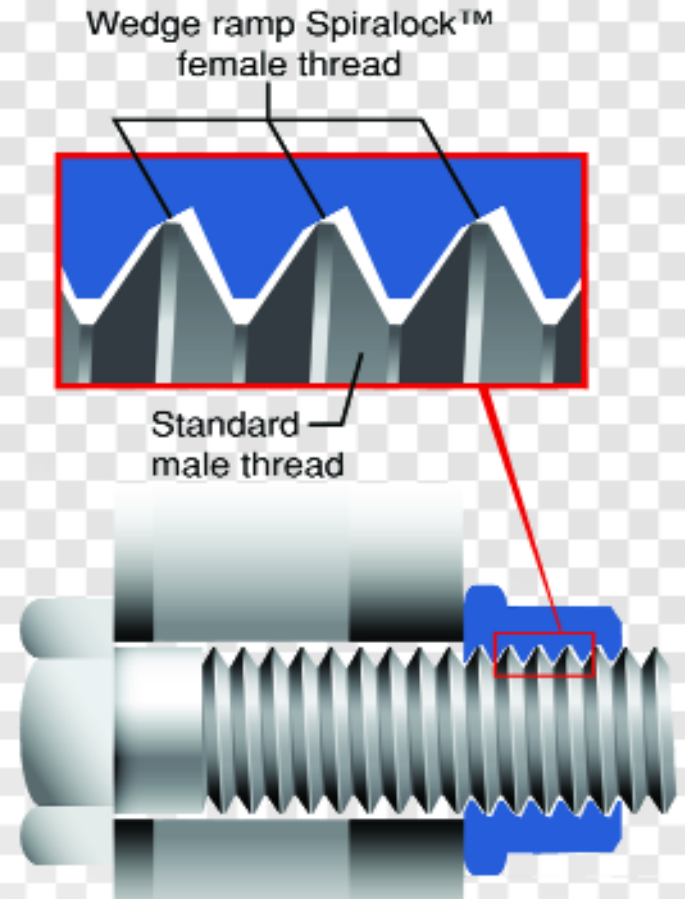

How Spirallock is Different:

SUPERIOR FATIGUE STRENGTH

The fastest, most cost effective and easiest way to improve joint fatigue strength is to specify a Spirallock nut or mating female thread. NO OTHER thread locking method provides both superior thread locking AND dramatically improved fatigue resistance using the same standard bolt.

"For reliability, the manufacturing process, and cost performance, they offer an edge over traditional methods. Especially when it comes to laming extreme forces and ensuring safety, they're a win-win fastener choice for engineers, OFMs, and the vehicle end user."

Frank Metelues, Design Engineer at Dana Corp.

Among Our Customers are:

- Ford • McLaren • Honeywell • SAAB • Land Rover**
- DAF Truck • Volvo • Airbus • Glenair • Raytheon Systems**
- Moog Controls • MBDA • Thales • Boeing • BAE Systems**
- NASA • Northrop Grumman • Hamilton Sundstrand**

For more information,
call us at:
+44 (0) 1604 546236
Or fax us at:
+44 (0) 1604 769066
Email:
sl-europe@spirallock.com

Visit our website for an
animated demonstration

www.spirallock.com

Your Threaded Fastening Solution

HOW TO: Bond dissimilar materials

Choosing the best adhesive tape

More and more applications are now emerging where dissimilar materials need to be joined. These can create some interesting challenges particularly where the joint line has residual or induced stress

Adhesive technology has come a long way since the initial adhesives used such as tar, animal glues, spruce gum and fish glues. Most technical adhesives selected today are now application related.

The decision of which two materials are to be bonded is often already decided by the time that the customer contacts the adhesives specialist.

To fully understand the technical demands, the customer is first qualified from information falling into the specific categories listed in the table below. When considering two similar materials, the selection process is reasonably straightforward but with two dissimilar materials there often have to be compromises.

Table 1: Specific areas of qualification

- Application
- Base material chemical compositions
- Coefficient of expansion of the two materials
- Operating conditions (temperature, humidity and chemical attack)
- Designed stress loadings & type
- Method of assembly
- Design life
- Specifications required
- Sizes and thicknesses required

When the requirements have been qualified or determined they are priori-

tised to allow the technicians to initiate preliminary testing and evaluation.

Where the surface energy levels of the two materials are above 36 dynes there is usually no need for any mechanical or chemical pre-treatment apart from a standard IPA wipe to remove dirt and grease. If one or both materials have a lower surface energy level then 36 dynes, there are two courses of action. Either a special low surface energy tape can be employed or a surface pre-treatment such as plasma, corona, flame or a wet applied compatible primer will be recommended. The selection of these alternatives is often limited by the working practices and or environment that production and assembly takes place. If the overall stresses within the joint are high then often pre-treatment combined with a harder adhesive tape will often give better results.

The expansion of the materials over a given temperature range can be overlooked when providing a solution. This can be calculated using coefficient of expansion figures for the relevant materials. A good example of this is a car side rubbing/protection strip. The length of the side moulding will have a large influence on the solution particularly on large three door cars. The expansion of thin painted metal is very different to that of a plastic material that has a large expansion rate. To compensate for this we often use a foam tape which absorbs the induced



The assessment room can test materials in shear and peel

stress due to temperature expansion and contraction. Some rigid glues will often fail due to their inability to handle large amounts of expansion.

Where the materials are very different, if required, a specialised tape that has two different adhesives matching the technical requirements can be developed. Adhesive tape specialist Lohmann UK has established a test room capable of testing materials in shear and peel which are standard tests conducted to either DIN1939 or DIN 1943.

Long term dynamic testing is also available and when providing a bonding solution, the use the customer's own materials for testing in a way that closely represents the application and final conditions is preferred.

The simplest solution is often said to be the best but in practice 85% of the adhesive applications designed by Lohmann are specials which are exclusive to the customers who purchase them.

The company recently built a fully programmable water test unit for one customer's test programme and the company is currently building an automatic laser activated shear testing unit that can handle parts up to 2 metres square.

LOHMANN TECHNOLOGIES UK 01296 337888

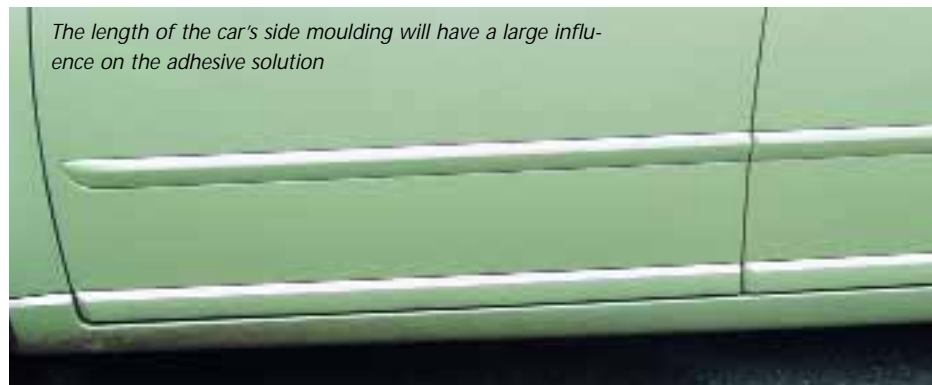

The length of the car's side moulding will have a large influence on the adhesive solution

HOW TO: Bond dissimilar materials



Ribcraft designs and manufactures 150 custom rigid inflatable boats a year

Olympic security and rescue boats are adhesive bonded for rigidity

Resin mixing equipment played a key role in the on time delivery of rescue boats designed for use in this year's Olympic sailing regatta in Portland and Weymouth

Early Olympic success goes to Ribcraft, a company based in Yeovil which has successfully delivered 64 security rescue boats which will be used in all the outdoor water sport events at the 2012 Olympic Games.

To comply with this tight schedule a different production method was required, which needed to consider available factory space and labour because normal production had to continue to satisfy existing customers. The conventional hand layup method would have taken up too much space in their factory so a

new concept was created, which meant three pre-formed layers being brought together and bonded. This would enable batch building 10 boats at a time, the problem now was how to bond them together without any mechanical fixing.

After extensive trials, Crestabond M1-30 10:1 ratio structural adhesive from Scott Bader was chosen due to its high tensile strength and speed of use in this difficult and challenging application. Due to the volume of adhesive being used, Ribcraft chose to use Liquid Control bulk dispensing equipment to ensure accurate



Ribcraft security rescue boats will be used in all the outdoor water sport events at the 2012 games



dispensing and mixing of both parts to maximise bonding performance.

Liquid Control has specialised in resin mixing equipment for 40 years and had the expertise and experience to supply equipment suitable for this task. Ribcraft founder Mark Gardiner commented: "For the Olympic boats we used a different manufacturing process which meant we had to structurally bond together three pre-formed sections and it was vital that the mixed adhesive performed extremely well because that's all that is holding

them together. I realised early on that the adhesive is only as good as the quality of mixing and Liquid Control gave us the precision and technical support we needed and with the added benefit that we were able to save money by reducing resin wastage because of the accuracy of the Liquid Control equipment, which also enabled us to control the adhesive placement precisely ensuring optimum adhesive strength."

Gardiner has long had a passion for subsea diving and in 1991 he decided to

design and manufacture his own boat that would be better suited for his hobby as there was nothing on the market at the right price and specification for his diving needs. This was the beginning of what is now a dynamic company employing 38 people, designing and manufacturing 150 custom rigid inflatable boats a year, with an annual global turnover of £4million.

Ribcraft's sales market has been the hobby and leisure sector. However, this has changed over the last few years with



Bulk dispensing equipment ensures accurate mixing of both parts of the adhesive to maximise bonding performance

the main expansion being in the professional areas of marine security, involving police and private contract companies who patrol against terrorist, drug and people trafficking. And so it was against this background that Ribcraft received the tender to quote, one of twenty nine that was sent out worldwide from the Olympic governing body, to manufacture 64 safety rescue boats for the 2012 Games. This process started in 2009 and concluded with Ribcraft being awarded the contract in 2010 worth £800,000. Work started on the boats in November 2010 and finished on time in June 2011.

LIQUID CONTROL 01933 277571



The manufacturing technique enables batch building of 10 boats at a time

Methacrylate structural adhesive

Crestabond M1-30 is a toughened, two component acrylic adhesive designed for bonding composites, thermoplastics and metals. This new generation of structural methacrylate adhesive meets the bonding requirements of most assembly operations, demonstrating good impact, peel, shear, compressive strength and fatigue resistance properties across all bonded parts. The adhesive is a primerless adhesive, requiring only minimal surface cleaning of the substrates to be bonded and demonstrates high toughness in all assembled parts with a gap filling capability up to 50mm.

The material is supplied ready to use in pre-packed 400ml co-axial cartridges and in bulk (20 litre pails and 200 litre drums). Prior to bonding, ensure the substrate surface is clean by following instructions provided. Bulk dispensing equipment should be in good operating condition. Dispense the adhesive at slow rate initially onto a non-

bonding surface until the bead colour is a uniform opaque grey. Check the dispensed bead for cure quality before beginning the bonding assembly. Dispense enough adhesive to fill the bond gap before parts are mated. Avoid dry bond by using adequate pressure to mate parts, and clamp properly to prevent joint movement.

All these processes must be completed before the working time of the mixed adhesive expires. To ensure thorough cure, the adhesive must be applied at temperatures between 18°C and 26°C. The effect of temperature upon this working time can be seen in the graph above. The viscosities of both adhesive and activator are affected by temperature. To ensure consistent dispensing in meter-mix equipment, adhesive and activator temperatures should be held reasonably constant throughout the year.

SCOTT BADER 01933 663100

BONDING DISSIMILAR MATERIALS

Thinking through the bonding challenge

One of the biggest challenges in bonding and sealing applications in manufacturing industry is coping with dissimilar substrates. An adhesives expert provides some practical solutions

Commonly encountered materials such as plastics, metals, rubber and wood exhibit such different properties, especially under extreme or volatile conditions for example temperature, humidity or exposure to ultra violet light that manufacturers of adhesive tapes or adhesives are obliged to look carefully at individual applications before making a recommendation.

Adhesive tapes have some inherent advantages; for example they tend to adapt well to surface and contour changes and they exhibit high stability under dynamic conditions. Leading tapes supplier tesa advises customers that it's useful to apply three elements of the application when evaluating the use of adhesive tapes on dissimilar materials.

Surface energy is the excess energy at the surface of a material and is important for any adhesive technology because the surface energy of a substrate influences the ability of an adhesive to 'wet-out' or

spread out evenly on the surface. If wetting is inhibited by a low surface energy then it is only possible for a weak bond – if any – to be formed. Ideally, the surface energy of the adhesive should be appreciably lower than the surface energy of the substrate to which it is applied, typically between 2 to 10 dynes/cm. However, an acceptable bond can still be achieved if the surface energy of the adhesive is equal to the surface energy of the substrate.

An example of a well-known material with a very low surface energy is Teflon, which registers only 18 dynes/cm at 20°C. There aren't many substances with a lower value and certainly nothing which can be used to form the basis of an adhesive especially when the surface energy of the adhesive would need to be anywhere from 8 to 18 dynes/cm.

Most plastics, such as PE and PP, have a surface energy ranging from 30 dynes/cm while PET is higher with a

value of 44 dynes/cm. Glass is anywhere between 250-500 dynes/cm and metals can be as high as 1100 dynes/cm (copper). Adhesive tapes can bond securely to many plastics and for glass and metals it is also highly effective. Additionally, the peel adhesion level can be increased by choosing a tape with a high coat weight of adhesive and surface energy can be increased by the use of primers or other treatments.

Surface characteristics

It is important to know if the surfaces to be bonded are rough or smooth as it will influence the choice of adhesive tape. For example, if both surfaces are smooth, such as glass or metal, then a tape with a filmic carrier is ideal. If however, the surfaces are rough or uneven, or if there is a discernible gap between the substrates when they are placed together, a double sided tape with a thicker carrier such as a foam tape should be used, such as tesa 4952.

Expansion and contraction at temperature: Solids expand or contract as temperature varies, with this change in dimension occurring in all directions. However as they don't all expand and contract at the same rate, then depending on the difference, increased stress can be placed on an adhesive bond. This means that the type of carrier must then be taken into account when choosing a tape, and in such cases a foam tape has often been preferred as in construction it is able to accommodate such dimensional changes. However, for very demanding and critical applications, tesa's ACX+ product offers improved performance due to the viscoelastic properties of the acrylic core, which provides the basis for this new family of adhesive tape.

Permanent bond

ACX+ is also good for bonding to substrates with a low surface energy, such as



Tesa 4965 applied to low surface energy plastics



many plastics and powder coated materials. It provides a permanent bond which can last for tens of years and is especially resistant to the effects of extreme temperatures, chemicals, UV radiation, and vibration.

When these criteria have been taken into account, users will find that there are other benefits available from using adhesive tapes which may influence the buying decision. Typically these tend to be the aesthetic properties – clear joints, no wet-out or oozing at the edges, no contact corrosion and clean removal where necessary – together with functional characteristics such as good peel resistance, noise dampening properties, the ability to deal with very thin component parts and high processing safety.

As part of its philosophy, tesa is able to provide technical, research and test facilities in addition to on-site support in order to establish positive product recommendation and potentially assist with in-line process contribution such as applicators and dispensers.

Whatever the ultimate solution, a thorough approach is certainly recommended when dealing with dissimilar materials.

TESA 01908 500235

DYMAX
Adhesives and Light Curing Systems

**Ultra-fast,
clean
bonding**

Now you can achieve strong, cosmetically excellent bonds faster than the time it takes to read this sentence. Dymax Ultra Light-Weld solvent-free UV/visible light cure adhesives improve productivity, reduce assembly costs and enhance safety, with cosmetically excellent bonds. For plastics, metals and glass.

01865 842842
www.intertronics.co.uk/adhere
sales@intertronics.co.uk

adhere™
better bonding from intertronics

HIGH PERFORMANCE ADHESIVE TECHNOLOGY



- **1 & 2 Part Structural Adhesives**
- **UV Curing Adhesives**
- **Conductive Adhesives**
- **Instant Adhesives**
- **Ultra High Temperature Adhesives**
- **High Performance Adhesive Tapes**



Bonham Drive, Eurolink Industrial Estate,
Sittingbourne, Kent ME10 3RY

www.eurobond-adhesives.co.uk
sales@eurobond-adhesives.co.uk

T 01795 427888

Eurobond
ADHESIVES LIMITED

HOW TO: BOND DISSIMILAR MATERIALS

Selecting a suitable bonding system

Joining dissimilar materials can be quite a challenge, especially when traditional methods of joining such as welding become impossible. FAST looks at the benefits of adhesive bonding and considers some problems which have to be overcome

How would a manufacturer approach the problem of joining an aluminium extrusion to a sheet of composite? For a plastic to plastic joint you may have considered using a solvent to weld the parts together but this method of joining is simply not possible if you wish to join plastic to metal. Mechanical fasteners can offer a simple, cheap solution but these can cause areas of high stress where they are located or, if a hole needs to be drilled, the structural integrity of the part may be compromised. Mechanical fasteners are often unsightly, add to component weight, increase drag, may rattle or vibrate, and if you're accident prone, may be one more thing you can catch yourself on!

tle, they are less likely to be tampered with or vandalised by opportunistic troublemakers and they create a seal with no leak paths, making them ideal for things like boats. They prevent electrolytic corrosion; using the wrong type of metal fastener into a different metal could cause corrosion. And another important benefit is the choice of application method, cure speed, strength and flexibility to suit application.

However, using adhesives does come with a number of considerations and limitations as well but being aware of and addressing these issues in the design stage will enable a successful, high performance end result.

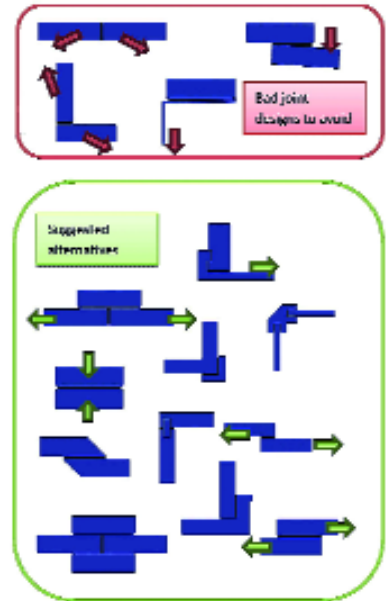

Examples of good and bad joint designs – arrows indicate direction of force on joint

teners are used. Sometimes this is so bad glass can shatter or other materials can warp or become bent.

The component substrates need to be allowed a degree of movement to cope with differential thermal expansion and contraction so selecting a flexible adhesive and increasing the glue line thickness (gap) between substrates can also help reduce expansion and contraction stresses.

The table below shows the different thermal expansion figures for common engineering materials.

To put the above figures into context, if you were to bond a metre length of polyethylene to glass and applied a temperature change of +20°C, the PE will expand almost 4mm more than the glass. When curing adhesive, it is a good idea to cure them at the temperature at which it would be normally operating. This helps keep stresses minimal between dissimilar materials. A useful website to help with calculations is at <http://www.calculatoredge.com/calc/exp.htm>.

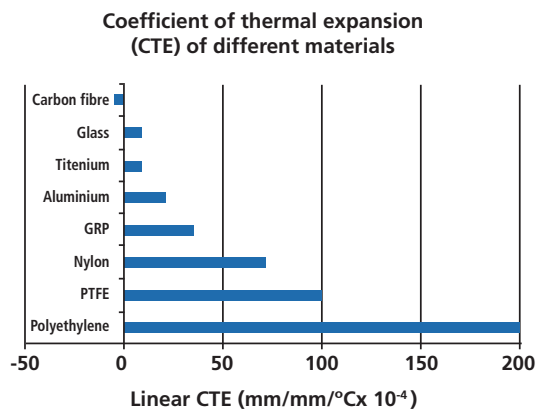

Coefficient of thermal expansion (CTE) of different materials

Bonding components with adhesive offers a solution to this joining problem and can offer a number of benefits such as better stress distribution between components with no weak spots where stress could be concentrated. An adhesive bond offers a more streamlined appearance and requires less processing; there is no need to drill, which in the case of glass could be a massive benefit.

Bonds are lightweight and will not rat-

Surface Preparation

To achieve the highest strength bond and best durability it may be necessary to prepare or prime the surfaces you wish to bond. Different materials have different requirements but on the whole, everything needs to be clean, dry and grease free. Metals generally need to be abraded and degreased with solvent – but you wouldn't normally use this surface preparation technique on plastic! Certain plastics such as polypropylene or polyethylene need significant surface preparation before bonding due to their non-stick nature. On composites such as carbon fibre or GRP, however, minimal surface preparation is necessary, although you may need to abrade the surface when bonding the gel coat side of GRP.

Thermal expansion

Expansion and contraction rates also require consideration. If you have a long section of aluminium extrusion you wish to bond to a material such as glass you could run into problems when the components expand and contract. Of course, this is not just a problem when using adhesives but often when mechanical fas-



There are many considerations when selecting an adhesive

Joint Configuration

Using an adhesive has the benefit of increasing joint design possibilities. Complex joint configurations and gap filling can be considered whereas these options are limited when welding or using mechanical fasteners. Building in a glue line thickness control can help minimise stresses between dissimilar materials. Normally a gap of about 250µm would give optimal strength performance combined with allowing a degree of expansion and contraction between substrates. You can control the glue line thickness by using very thin lengths of wire of the desired gauge, or by using glass ballotini spacer beads, which can be sprinkled on very easily like salt on your chips!

Service conditions

To enable selection of the best adhesive for the job, it is important to consider the service conditions the adhesive will be exposed to. These include temperature changes, maximum and minimum temperature performance, chemical exposure, environmental exposure and factors like rain, humidity, sunshine, frost and, of course, combinations of all of these. For example a chemical, which is relatively innocuous at room temperature, may become quite aggressive when hot.

Adhesive Preferences

So having selected your dissimilar substrate materials, designed your joint, prepared the surfaces and confirmed that service conditions are not going to be a problem, you may now be faced with 100 or more adhesives to choose from. To help narrow down your options, the engineer must have the answers to the follow-

ing questions ready:

- What is your preferred cure speed – instant, seconds, minutes or hours? In other words how quickly do you need to assemble the parts and have them cured?
- Which cure method do you prefer – does it have to be room temperature curing, can you cure in an oven or would a UV-lamp be feasible?
- If using a two-part adhesive, do you prefer to measure and mix, use

a gun and static mixer nozzle, a spray activator or brush on initiator and resin? Will your process be automated? Do you want a single part adhesive?

- What viscosity do you prefer – water-thin or thixotropic like sour cream or high viscosity paste like peanut butter? If you have a gap to fill then you need to use a high viscosity adhesive. Certain adhesives cure mechanisms only allow them to cure in minimal gaps, such as cyanoacrylate and anaerobic chemistries, even if they look like they can be piled up into a thicker layer they may not cure.



Toughened epoxies are a popular choice for bonding filters into end caps

Success Stories

Single-part heat-cure epoxies are amongst the highest strength, highest performance adhesives on the market. In comparison strength tests, they significantly out-perform welding and brazing joining techniques for bonding tungsten carbide to steel for applications such as wear tips on conveyor systems and tooling such as rasps. Using a rubber toughened heat cure epoxy not only gives superior strength performance, but gives the flexibility required to cope with dif-

ferential thermal expansion and contraction. The key to obtaining the best thermal performance is to cure the adhesive at the temperature at which the component part is normally operating to keep thermal expansion and contraction stress minimal. Rubber toughened heat-cure epoxies are also popular for bonding diamond tips into cutting tools. Again, an application where differential expansion and contraction, vibration and impact resistance is essential combined with a good resistance to high temperatures. The same adhesive products are a choice method of sealing heat exchangers and have opened up new potential for the heat exchanger industry by allowing the introduction of new lightweight materials which can't be welded, such as aluminium fins and tubes to nylon end plates.

Rubber toughened anaerobic sealants are particularly popular in the plumbing industry sealing copper, brass and steel components such as for pipes, ballcocks, valves, hot water cylinders, immersion coils, solar cylinders and pipework. In a temperature changing environment and on dissimilar metal surfaces, the rubber toughening allows for expansion and contraction, thus preventing leaks. Copper cylinders can be prone to pin prick holes when welded so using adhesive instead helps keep the integrity of the tank.

Toughened epoxies are ideal for a wide variety of applications involving dissimilar materials. Thanks to their excellent durability and resistance against chemicals, they are a popular choice for bonding filters into end caps.

Bonding glass to metal can be a worry for product manufacturers, particularly if bonding a large area on an application that will be exposed to a range of temperatures, there is the risk of the glass shattering when expanding or contracting. This is not just an issue with bonding. It could also be a problem for mechanical fasteners if there is not an allowance in the machining tolerances. The benefit is, if you choose the correct adhesive with a degree of flexibility and elongation properties, you will not only save having to machine holes for mechanical fasteners and risk cracking the glass but you will also be able to cope with the expansion and contraction between the dissimilar substrates.

PERMABOND 01962 711661

HOW TO: JOIN SHEET METAL

Clinching system cuts manufacturing time

A sheet metal joining system, adopted by a grain conveyor manufacturer to replace spot welding of galvanised sheets, has reduced manufacturing time and costs by 85%

In 2014, Skandia Elevator will be celebrating its centenary. From humble beginnings, this family-run business, now in its third generation, has grown to become the largest manufacturer of custom-designed grain movement conveyor systems in Europe. Customer requirements range from systems installed into barns on small farms to large-scale production facilities in the grain industry.

Skandia Elevator's success is the result of careful planning, innovation and constantly looking for ways to cut costs without sacrificing quality. Tog-L-Loc, a sheet metal joining system from BTM, has proven to be an effective tool in doing just that.

Skandia Elevator has used spot-welding for many years, which when joining galvanised steel, needs a secondary operation of 'priming the welded material to prevent rust'. Tog-L-Loc joining does not damage the galvanised coating, leading to an immediate cost saving in materials and labour.



The system joins in a single press stroke

Another advantage is the extremely good tool life of the system with over 300,000 joints common from a single set of tools, far greater than spot-welding and no weld-tips to dress.

Successful trials, which proved to reduce manufacturing time from 4000 hours to 600 hours showing a massive saving of 85% in time and costs, convinced Skandia Elevator to take out the old spot-welding equipment. This was replaced with a modern BTM robot cell complete with an Electrodrive unit manufactured by Kistler, which unit allows for multiple metal thickness combinations and joint monitoring via a process control module. Material thickness ranged from 0.9mm up to 2.0mm all joined using one set of tools.

Anders Ingvarsson, the owner of Skandia Elevator commented: "BTM's servo controlled clinch gun has gone smoothly since its inception; no problem

to make 300,000 joints with same tooling and with full process control for all clinch joints.

"This robot cell is capable of producing what took two people 4000 hours to manufacture in just 600 hours. The maintenance is minimal when the process is very closely controlled. Furthermore, the equipment can handle a greater variety of sheet thickness without changes to the clinch tools.

"We chose the clinch method for environmental and economic reasons as well. This Tog-L-Loc clinch equipment is cost effective and reduces spare part consumption and maintenance," added Ingvarsson.

Tog-L-Loc is a cold-forming clinch process, which uses a special punch and die to form a strong interlocking joint within the metals themselves. The result of the process is a round, button shaped extrusion on the die side of the assembly,



One set of tooling can produce 300,000 leak-proof joints

and a small cylindrical cavity on the punch side. The joint is comprised wholly of the sheet metals that were joined. No external fasteners or welding is utilized in the process.

The system is capable of joining plain, coated, and dissimilar metals without rivets, screws or other fasteners while eliminating spot-welding operations; so no sparks, fumes or soot. The system joins in a single press stroke and enjoys long life with one set of tools producing up to 300,000 joints. Once made, the resulting leak-proof joints are strong and highly fatigue resistant and can be non-destructively tested with a simple gauge.

Tog-L-Loc is proving an alternative that is a fast, economical and consistent sheet metal joining system compared to spot-welding and riveting, and is used worldwide to assemble automotive parts, white goods, electronics and more.

BTM (UK) AUTOMATION PRODUCTS
01767 677001



Spot-welding equipment was replaced with a modern robot cell

tesa

Experts in tape engineering

For help and technical advice on our range of double sided, masking, and cloth tapes or converted products please phone:

01908 500235

for your nearest authorised tesa distributor

tesa UK Ltd
Worwood Drive, Risborough, Milton Keynes, MK14 1JQ
Tel: 01908 500235
www.1066600.uk
www.tesa.co.uk

Fixed. And fastened. By Hopwood.
In partnership with Ejot.

EJOT®

PT® screw

Available from stock at Hopwoods.

Tel: 0845 519 6066

E-mail: sales@rhf.co.uk

Hobert Street • Whitehill Ind. Estate
Stockport • SK1 1NS

Leading the way in fastener distribution, quality and service

www.rhf.co.uk



SpecialtyFasteners UPDATE

RUGGED SOLUTIONS FOR RUGGED SITUATIONS



QUICK RELEASE PINS

QUICK RELEASE PINS are hand operated and non-threaded, which means they are fast and easy to operate. They are generally used to carry shear loads and are available in plated steel and stainless steel. There are many application areas such as retaining stores and bodywork panels on helicopters, aircraft and military vehicles of all types.



Camloc

KEENSERT

KEENSERT inserts give high strength joints in low strength materials. Typical applications are transmission housings, electronic equipment and suspension units. Available in inch and metric thread sizes, their stainless steel solid bushing configuration guarantees internal thread quality before installation. No special tools are required and standard taps and drills are used for hole preparation.



Call an SFC engineer today on **01803 868677** to discuss your fastening requirements

ENGINEERED SOLUTIONS FROM



**SPECIALTY
FASTENERS &
COMPONENTS**

Specialty Fasteners & Components Ltd
Seymour Wharf, Steamer Quay Road,
Tolnes, Devon TQ9 5AL
Tel: 01803 868677
Email: sales@specialty-fasteners.co.uk

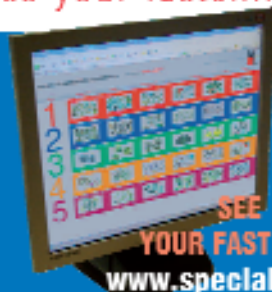

SEE MORE SOLUTIONS TO
YOUR FASTENING PROBLEMS AT
www.specialty-fasteners.co.uk

TOP TIPS: SHEET METAL FASTENING AND JOINING

Finding the optimum bond

Metal has a high surface energy (HSE) which makes it easy for an adhesive to bond to it. It is also smooth, which means double sided tapes with any type of carrier can be used, increasing the choice of the most suitable tape for the intended application

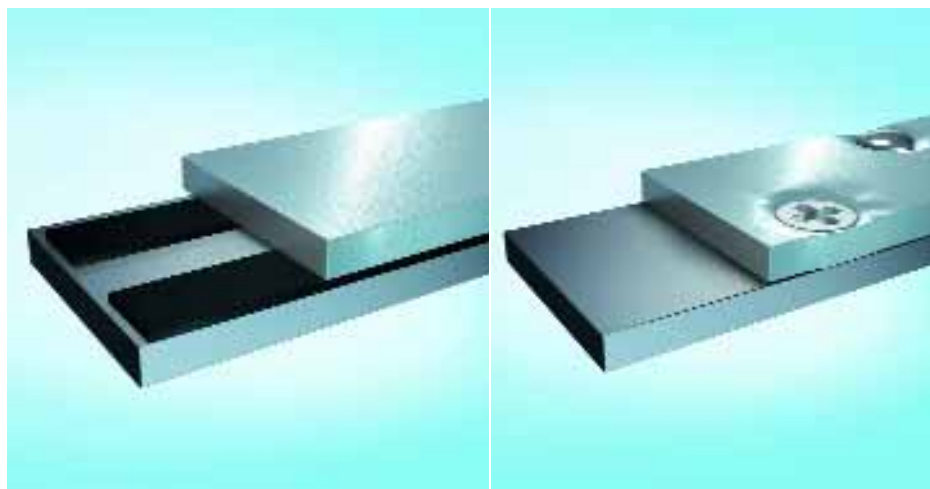

Bonding metal with double sided tapes (left) has clear advantages over screws and rivets

To ensure an optimum bond is achieved when joining metal sheet or strip with adhesive tapes, there are some initial considerations to take into account. First, as metals often come with a thin film of milling oil, it is essential that this is removed and that the surface is clean, dry and free of any contaminants.

Secondly, it is preferable for tape to be applied at around 18-22°C. The substrates to be bonded should ideally be at the same temperature. If they have been stored in a warehouse overnight during the winter, it is advisable to allow them to warm up and let any moisture evaporate. If either the tape or substrates are cold, this affects the ability of an adhesive to wet-out – spread out evenly on the surface.

Finally, firm and even pressure needs to be applied across the tape to activate the adhesive. Rollers aid this process and this is typically all that it is required.

Advantages of using double sided tapes:

- Double sided tapes provide a very good initial bond – often enough to allow movement of the bonded part to the

next production stage. Depending on the type of adhesive, maximum bond strength is typically realised within three days

- No curing time is required, as is the case with wet glues
- Tapes are clean – there is no oozing of adhesive at the edge of a joint. This means there is no contamination and no additional cleaning required
- There is no need for protective equipment to be worn, as is the case with welding
- Typical warehouse conditions are appropriate for storage – say 22°C and 50% relative humidity
- Tapes offer equal distribution of stress across the whole of the bond area. This is in direct contrast to traditional means of bonding metals using screws, bolts and riveting which can lead to localised weak points and even damage the metal surface, leaving it vulnerable to corrosion.

One of the largest global tape manufacturers, tesa supplies over 800 adhesive tapes. As part of its tesacoheasion philosophy, the company offers on-site audits

focusing on process improvements, on-site technical support and product training as well as assistance with the development of standard operating procedures.

When applied, double sided foam tapes, such as tesa 4952, offer vibration and noise dampening properties. A very thin, almost invisible bond is possible with filmic tapes such as tesa 4965 (205µm) or even down to 30µm with tesa 4973, depending on the application.

tesa's new ACXplus range offers a convenient method of bonding and joining sheet metal. Extremely resistant to weathering, temperature, UV and chemicals, products within the range also provide a reliable water seal.

TESA 01908 500235

Trading since 1963 under the Beiersdorf banner, tesa UK was formed in 2001 as a wholly owned subsidiary of tesa SE. In total the business has more than 75 years of experience manufacturing adhesive tapes under the tesa brand name, including double sided, masking, protection, safety, cloth, duct and packaging ranges in addition to many products developed for specific industrial and consumer applications. tesa SE is itself a wholly owned subsidiary of Beiersdorf AG, which is responsible for the NIVEA skin care brand.

The company's prime markets extend from automotive, flexographic, printing, building supply, corrugated packaging, newsprint and paper production to painting and decorating.

ease and efficiency



Photo courtesy Jaguar Cars

The superb new Jaguar XJ.

Aluminium structure assembled using **Henrob** self-pierce rivets in conjunction with adhesives.

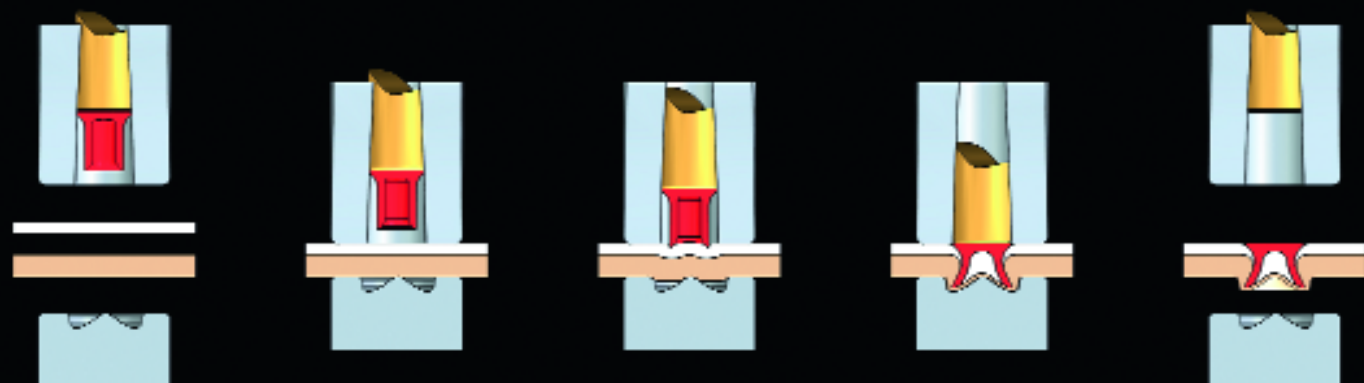

Henrob self-pierce riveting - the answer to today's joining issues.



- ✓ No heat, sparks or fumes.
- ✓ No hole drilling, swarf or alignment problems.
- ✓ Low noise, environmentally friendly process.
- ✓ Quick, clean and convenient.
- ✓ High strength and fatigue resistance.
- ✓ High joint quality and repeatability.

Interested?

Find out more at www.henrob.com

Henrob Limited
Second Avenue, Zone 2,
Deeside Industrial Park,
Flintshire CH5 2NX
Tel: +44(0)1244 837220
email: sales@henrob.co.uk

Henrob[®]
Innovative Joining Solutions

Just what the designer ordered

The trilobal Flowform screw offers higher reliability compared to more traditional sheet metal joining methods. FAST describes this market-led technology

Arnold Umformtechnik is a manufacturer of intelligent joining solutions and has become a development partner for many manufacturers in the automotive and electrical industries. The company has industrialised Flowform screws in response to the increasingly complex requirements for sheet metal joining. These triangular screws utilise the technology of flow-hole forming in the fabrication process.

The trilobal Flowform is a cost optimised solution that offers higher process reliability for threaded fastener joints and considerable advantages over alternative sheet metal joining methods: ease of loosening, accessibility, positioning, reassembly with threaded fasteners, freedom from fabrication residues.

The market trend is to constantly reduce the thickness of sheet metal com-

ponents while at the same time requiring their joints to be stronger. Particularly with regard to joining methods, there is a demand for cost-optimised high-tech solutions. The screw heats the sheet metal by a combination of axial force and relatively high driver speed.

After the screw penetrates the material, the trilobal shape causes a metric thread to be formed in the host material, which can accept a standard metric screw if repairs are necessary. After controlled-torque assembly, the formed hole adapts precisely to the shape of the screw. This assembly process eliminates the necessity for additional securing components, as well as the need for various component preparation steps such as drilling or punching.

Fabrication options with or without prefabricated holes in the clamping plate are also possible. The decisive factor here is the thickness of the component to be clamped. Compared with previously used standard self-tapping screws, Flowform screws have considerably higher pull-out and preload forces, as well as higher over torque values. The special triangular cross-section of the fastener results in considerably better performance than

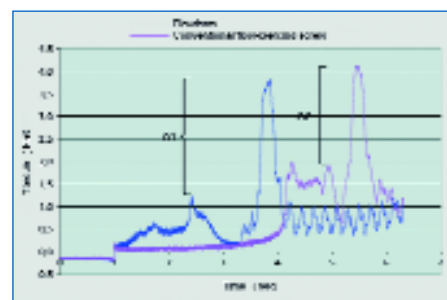

Figure 2: Flowform screws achieve a significantly larger delta between the thread-forming torque and the tightening torque

conventional systems with a circular cross-section.

Compared with them, the triangular Flowform screws achieve a significantly larger delta between the thread-forming torque and the tightening torque (see figure 2). This results in considerably higher process reliability for threaded fastener joints because drivers can be operated with a larger cut-off window. In addition, users benefit from a wider range of driver options and significant simplification of assembly process monitoring. Flowform screws also offer considerable advantages over alternative sheet metal joining methods, such as gluing, riveting, clinching or press-in components.

ARNOLD UMFORMTECHNIK +49 7947 821 170



The six steps of flow-hole forming in the Flowform technology

Stainless steel solutions

For a growing number of applications in the food, chemical and pharmaceutical industries a wherever rigorous hygienic principles and regular difficult ambient conditions make it mandator

INOX
Stainless Steel

ELESA (UK) LTD
Phone: 01526/322670
Fax: 01526/322619
sales@elessa.co.uk

STANDARD MACHINE ELEMENTS WORLDWIDE

www.elessa.co.uk

PRODUCT REVIEW: THREADED FASTENERS

Screw family comes of age

The launch of a screw family some 35 years ago revolutionised the application possibilities of thermoplastic assembly. The Ejot PT is still arguably the most advanced screw family for direct fastening into plastics. FAST follows the development of this fastening family

It's fair to say that before the launch of the original Ejot PT screw back in 1977, dynamically and thermally stressed components could not be fastened directly, and only subordinate components were joined using conventional or traditional methods. For main assemblies, designers relied upon traditional fastening techniques such as screws with metal inserts.



Flank angle described

Joining mouldings and components using a thread forming screw is economically efficient, detachable and recyclable. Assembly takes place after the moulding process and eliminates the need for metal inserts or bushings to be placed into the tooling, thereby drastically reducing the risk of tool damage. With a flank angle of 300, it is the Ejot PT's thread geometry that made this possible. By generating a minimal radial stress, an efficient material flow into the recessed thread root is created. The optimised pitch provides excellent self-locking of the thread and guarantees a balanced load ratio between plastic and steel.

Ejot's initial objective was to return the design focus to loadings rather than assembly torques, and the resulting PT screw has become something of a benchmark for reliable direct assembly into thermoplastics, virtually opening up endless fields of application across all industry sectors. With performance demands on fastening technology constantly increasing, the on-going process of

upgrading the advanced characteristics of this clever fastener has moved on.

Material relaxation through raised temperature conditions, such as found in under-the-hood applications in the automotive industry, became the company's next focus and Ejot's research and development team moved to address the combined effects of thermal and dynamic stresses within an assembly.

Optimising the thread pitch and angle meant arriving at a perfect match between thread and boss design. In reality that means a screw to material relationship with sufficient empty space to create a compulsion free absorption of the displaced thermoplastic material. Flank geometry, thread pitch and core diameter are of equal importance in achieving optimum performance. The long term visco-elastic effects of time and temperature on clamp load could now be addressed, which resulted in the development of the Delta PT screw in the early 1990s.

Online prognosis

As new application possibilities presented themselves, designers needed to evaluate the long term performance benefits

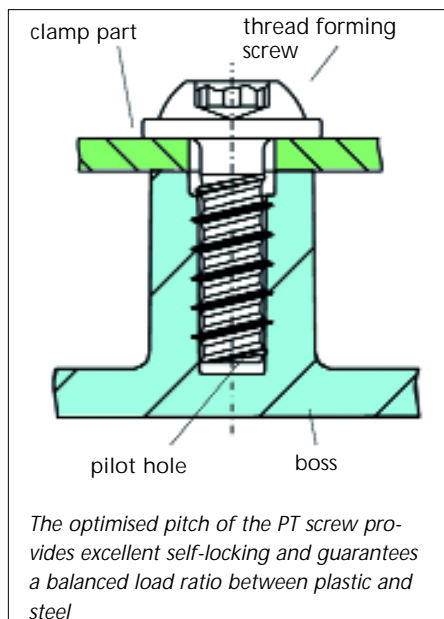

of employing direct fix technology. To complement the innovation behind the fastener itself, Ejot created highly sophisticated forecasting software called Delta Calc, which utilises fastener and boss dimensioning to provide application engineers with an online prognosis and also assists in determining the load carrying capability of a direct assembly joint. The program also provides lifetime and durability forecasting under temperature and static stress.

The Delta PT screw and the Delta Calc forecasting program now combine to create a system that allows a well-founded pre-design of the joint at conceptual stage. Apart from the facility to obtain data relating to long term performance, it is now possible make adjustments prior to full production. This will improve the overall quality and effectiveness of the joint, whilst minimising the need for prototype testing which delivers obvious cost benefits to the end user.

This combination of high quality product and performance-predictability continues to address new application possibilities and derivatives of the screw will address these in future. The Duroset version of the fasteners, for example, utilises a modified thread form to overcome the brittleness of certain thermosetting plastics, whilst the possibilities created by special derivatives made from alternative materials has become the new ambition of the research and development team.

EJOT 01977 687090

Fasteners distribution partner provides low volume channel

Opportunities to help with small to medium enquiries for a classic fastener are challenging for a global manufacturer. So to create a low volume marketing channel for the PT screw family, Ejot UK needed a partner and has appointed Roy Hopwood Fasteners as a stockist for the fastener family

Hopwoods the company has been distributing high quality engineered products from stock and has provided technical assistance in the selection and application of the fastener since 1974. But Ejot required more than a stockist. They needed a valued partner, to assist in product specification whilst providing the customer with engineering expertise. With five experienced people in the field, and the ability to cover the UK, the choice was made to appoint Hopwoods as a key industrial fasteners distribution partner.

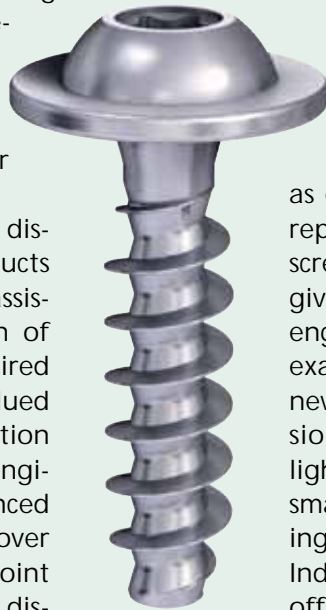

Fraser Hayden of Hopwoods commented: "This is a perfect fit for all concerned, including the UK marketplace. We have stock in place to satisfy short term project demand, and can react quickly to commercial or technical enquiries.

The manufacturer benefits from having an enlarged engineering sales resource, as well as enjoying the economies of scale that our stock replenishment orders provide. The genuine Ejot PT screw is now readily available from stock in the UK, giving users security that they are buying a highly engineered and proven component, produced to exacting standards. Hopwoods won't take on a new product line lightly, but in this case our decision was easy. The growing emphasis on lightweight structures, and the demand for ever smaller and lighter assemblies without compromising joint strength, means that the Ejot range of Industrial Products is a valuable addition to our offering."

ROY HOPWOOD (FASTENERS) 0845 519 6066



Fully automatic placement



Robot controlled placement





LESS IS MORE

Less cost... less time... less rework... less scrap... less pollution... less energy use...
less human error... less logistics... less inventory.

Want MORE reasons to use Profil's advanced sheet metal fastening system?

More payback... more productivity... more reliability... more accuracy...
more material types... more thicknesses... more fastener choice.

No wonder Profil pierce nuts and studs are specified by leading automotive manufacturers including Land Rover, Jaguar, BMW, Aston Martin, Mercedes, Audi, Renault and Ford.



Find out the benefits for yourself by calling Profil UK today on: 01530 276515
Profil UK, Unit 6 Whitwick Business Centre, Slonson Road, Coalville, Leicestershire LE67 4JP
Tel: 01530 276515 Fax: 01530 276516 www.profil.eu

PRODUCT REVIEW

A different approach to fastener design

The concept of fixing a buttress screw into a helix thread is an interesting option in manufacturing design. FAST highlights some of the advantages the system has over conventional methods by using some examples from a cross-section of applications

The High Torque Fastener System (HTFS) was developed to overcome some of the ever increasing demands being placed on industry to overcome new and more challenging complex designs. The concept of creating a geometric helix thread form with a complementary buttress screw was conceived as

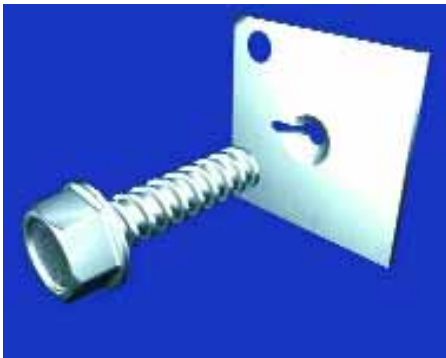

Fig 1: The High Torque Fastener concept geometry

an answer to a fundamental problem seen in everyday design and production. It's fundamentally a sheet metal fastening system where the nut element of a fastened joint is built into the sheet metal material as shown above (figure 1).

Due to the nature of the HTFS design, numerous manufacturing processes can

be removed due to the fact that the 'nut' element of the fastened joint is built into the sheet material. Time and money can be saved with pressed panels available and ready for assembly directly from the production press with no need for any secondary welding or mechanical processes. The system is also unaffected by any painting processes that may be used during production which can be carried out before or after assembly. The ability to remove processes also helps in improving the efficiency and output of the labour force. It does not mean that jobs will be lost as a result, but that it gives companies the opportunity to evaluate and distribute the labour in a more effective and efficient way to increase output without increasing costs. Process removal also saves energy and the environment and allows companies to reduce expenditure on capital equipment.

The geometry of the system does give the fastener system some enhanced mechanical performance characteristics which are integral within the design. Firstly the geometry enhances the sheet metal material due to the corrugation affect. As well as enhancing the strength of the material it also has the ability to withstand extreme vibration conditions. This is due to the fact that there is a small amount of deflection within the helix form, which tries to re-set itself to its original position when tightened down. The flexibility within the helix has a spring effect which gives it its vibration resistant qualities and enables the fastener to be utilised in automotive applications (figure 2) and applications where vibration resistance is a key attribute. This also allows for the removal of spring washers and patch technology.

Inventory and material reduction
One of the major advantages that the system brings is inventory reduction. The

system allows for the removal of inserts and spring washers, which means that fastener inventory will be reduced by a minimum of 50% as the nut element of the system is built into the sheet material. If we look at the control panel in figure 3 as an example which shows how a company was assembling before using conventional methods, and how it's being done now with HTFS. They were previously using standard nuts bolts as well as spring washers. This has now been replaced with a High Torque fastener and a six impression pressing. What this has done for the customer is not only reduce inventory but the assembly process is much more efficient now as well. One of their main assembly concerns previously was nuts and washers falling into the control panel.



Fig 3: Control panel using HTFS which allowed for the removal of nuts and spring washers at the top of the picture

The HTFS product has also assisted many customers where they have been able to rationalise on the panel gauges

Fig 2: Seating bracket in the automotive industry utilising High Torque



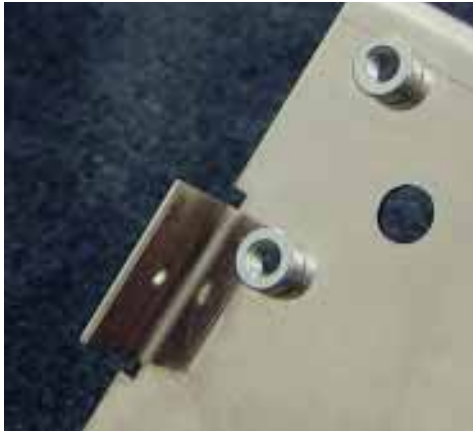

Fig 4: Example of material gauge rationalisation. Pictured above with inserts and below with the helix thread form



that they are using. If we take the example illustrated (figure 4), where the customer was previously using 1.2mm stainless steel and a conventional insert to assemble all their sheet metal work. Due to the nature of the application it was difficult to understand why the material being used was so thick. After further investigation and discussions with the customer it was found that they had to maintain that thickness due to nature of the insert that they were using. As a result of converting to HTFS the customer has reduced the panel thickness to 1.0mm and gained further cost reductions.

Assembly

The system is free running on insertion right up until lock down so the insertion torque required is significantly reduced which makes the assembly process easier for the operator and ultimately quicker. The system is also totally re-usable and can be used over and over again without loss of function which is particularly useful for inspection panels. The system also reduces the possibility of Repetitive Strain Injury due the shock impact.

Repetitive Strain Injury occurs from repeated movements over and over again which is something that assembly operators within the manufacturing industry are prone to. This is something which employers have started to take seriously in recent years and it is particularly prevalent in today's modern era of personal injury claims and compensation.

The HTFS product is being used by a number of customers in the information technology industry particularly on their racking systems. One example is shown (figure 5) where HTFS is now being used to fasten various components onto the main chassis as well as the main enclosures. The customer was previously using pierce and plunge fastening method which was giving them a high percentage strip rate during their assembly process. This meant that a large amount of their sheet metalwork either needed to be reworked or in some cases scrapped altogether. By converting over to High Torque their strip rate has been reduced to zero and there is no possibility of swarf getting into the circuitry.

Wide application range

The flexibility of the HTFS product means that it can be used in range of uses and it therefore does not restrict itself to a particular type of fastener application. Different product applications have their own advantages for adopting the system. On the one hand some applications adopt the system purely for cost reduction purposes without loss of performance where inserts are being used, and on the other hand the system may be brought in to improve quality or design issues that may be encountered with thread forming fasteners. Although the flexibility of the system allows for it to be used in very thin gauge material (0.5/0.6mm) right the way through to thicker gauges (2.5/3.0mm) there is a high probability that there are many applications suited for the HTFS system which have yet to be considered and developed fully. This can be said to be true for all innovations and new developments within the fastener industry. It is only by pushing them forward with an on-going process of questioning the way we do things and innovation will we continue to develop and find new and improved ways to increase efficiency and meet the market demands.

HIGH TORQUE 01792 466634

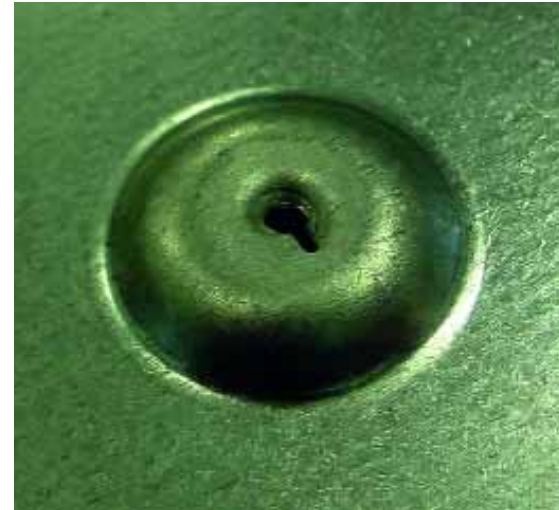

High Torque pressing after processing



High Torque pressing before processing



Fig 5: HFTS being utilised in the IT industry

FASTPRODUCTS

Electric bus design cuts vehicle weight

A body design for an electric bus uses an aluminium space frame, forged wheels and fasteners to save nearly a ton in weight



The use of an aluminium chassis and fastener components has reduced the weight of the BYD prototypes electric bus, recently launched in Changsha City, China, by a spectacular 1.2 tons

Alcoa has developed a new all aluminium space frame and bus design for Chinese automotive manufacturer BYD that has reduced the weight of a new electric bus body by 40% or nearly one ton, versus steel options. The first two BYD Electric Bus prototypes were launched in Changsha City, Hunan Province, China.

In addition to reducing the weight of the bus body, Alcoa solutions including Alcoa forged

wheels and Huck Spin fasteners reduced the overall bus weight by 1.2 tons in total. The combined weight savings are expected to help improve the overall range of the electric bus by at least 10%. The new bus has a range of approximately 300 km on a full charge.

BYD plans to produce thousands of the electric buses for the China and Southeast Asia markets and will also export the buses globally. Alcoa will be the exclusive supplier of the new bus design as well as sheet product from its Bohai rolling mill in Qinhuangdao, Hebei. Alcoa will also be the exclusive supplier of forged aluminium wheels and fasteners to the project.

The new bus design builds on Alcoa's leading capabilities in safe transportation design, includ-

ing automotive and ground transportation space frame technologies for leading brands such as Ferrari and Audi, among others.

"It is certainly impressive that we were able to drop more than 1.2 tons from the weight of BYD's new electric bus compared to steel," said Jinya Chen, President of Alcoa's Asia-Pacific region. "However, this design is about more than just weight. The new design is durable, corrosion resistant, and infinitely recyclable. It is expected to increase the range by at least 10% and withstand the rigors of everyday city driving."

"We are pleased to have worked with a global expert in transportation such as Alcoa as we began work on this new electric bus program," said Xie Shibin Vice President of BYD Auto Research Institute. "Alcoa's design and materials combined with our expertise in the market make this new bus the best in the industry in terms of emissions, range, safety and performance."

ALCOA FASTENING SYSTEMS
01952 204607

Alcoa is the world's leading producer of primary and fabricated aluminium, as well as the world's largest miner of bauxite and refiner of alumina. In addition to inventing the modern-day aluminium industry, Alcoa innovation has been behind major milestones in the aerospace, automotive, packaging, building and construction, commercial transportation, consumer electronics and industrial markets over the past 120 years. Among the solutions Alcoa markets are flat-rolled products, hard alloy extrusions, and forgings, as well as Alcoa wheels, fastening systems, precision and investment castings, and building systems in addition to its expertise in other light metals such as titanium and nickel-based super alloys. Sustainability is an integral part of Alcoa's operating practices and the product design and engineering it provides to customers. Alcoa has been a member of the Dow Jones Sustainability Index for ten consecutive years and approximately 75% of all of the aluminium ever produced since 1888 is still in active use today. Alcoa employs approximately 59,000 people in 31 countries across the world.



www.adhesives-show.com



www.fastenerexhibition.com

Spray adhesives suit large surfaces

From large format graphic displays and exhibition stands, to model construction and upholstery, bonding materials with a large surface area is one of the most important and challenging processes, especially when the substrates to be bonded are different and have varying weights. Adhesive tapes manufacturer **tesa** has launched a range of professional spray adhesives and cleaners for the large surface adhesion of different materials.

The different characteristics of these aerosol spray adhesives and industrial cleaners provide an efficient solution for most materials and different levels of adhesion. Developed for lightweight materials, such as paper, fabric and Styrofoam in particular, spray glue 60021 ensures permanent

adhesive bonding. Superior strength, especially on rough and porous surfaces such as foam and fabric, is offered by spray glue 60022, which also bonds heavy materials such as wood and metal. This product features a valve, which provides infinitely variable spray quantity control to ensure an even film of adhesive.

For applications where large surface materials are regularly constructed and then deconstructed, another challenge is presented in the process of temporary adhesion. With spray glue 60023, lightweight materials such as advertising billboards or posters can be easily removed and repositioned. This UV-resistant transparent spray creates a thin, even adhesive film. It can also be applied more thickly, or on both sides, to achieve permanent adhesion.

The company's 60040 product removes various types of soiling and residue and prepares surfaces for gluing and can be used to correct virtually any mistake made. The product eliminates adhesive residue, for example if glue is sprayed outside the intended area or the wrong adhesive tape is used.

TESA TAPES 01908 500235



Fold away handles add important safety feature

The fold away handle feature on **Elesa's** crank handles and hand wheels – whether solid or spoked – is an attractive and practical aspect of the company's range of standard machine components.

Fold away handles are frequently required in spaces where they would otherwise be a safety hazard, where a wheel is motor driven, for example, or where a protruding handle may catch clothing when operators pass by the equipment. By virtue of folding the handle itself into the body of the wheel, the problem is eliminated while retaining convenience and ease of use.

Solid hand wheels such as the ESW, VDS, VDT and VDO all have +IR options, as do the VRTP, ETW, GN322.3 and VR.FP versions. Elesa has also managed to incorporate a fold away handle into the EMW monospoke hand wheel and the MT crank handle. Revolving handles in resilient technopolymer or solid Duroplast are available to match the hand wheel design.

ELESA
01526
322670



Stainless steel lock for food and clean room areas

A stainless steel quarter-turn lock just released by **FDB Panel Fittings** has some exciting features that ensure its suitability for food processing and electronic clean room assembly areas. The easy to clean polished and rounded shape eliminates crevices that could trap debris, thus preventing accumulation of dirt and bacterial contamination by the use of conventional methods, including high pressure cleaning. There is a reduced risk of injuries and guaranteed germ free environment within the enclosure.

The new lock, designated 7-081, complies with Food and Drug Administration requirements and features special red silicone gasketing for easy identification. Additional features include electrical continuity by



use of a grounding nut to protect users against static discharge. The wide variety of cams available ensures that there is high application flexibility and optimal fit to frame width. Locks can be delivered pre-assembled under FDB's RocFast brand package.

FDB PANEL FITTINGS
0208 568 1616

Volumetric dispensing system gets a volume boost



The preflow eco-PEN 600 from **Intertronics** is a high precision volumetric dispensing system that takes all the features of the existing eco-PEN 300/450 and adds size. Maximum volume is nearly trebled at 16 ml per minute while minimum dose is just 0.015 ml, thus increasing the application scope of these systems, as well as enabling them to take on the bigger jobs where guaranteed 1% accuracy is required with continuous repeatability such as with robotic installations in electronics, component assembly, medical or laboratory type industries.

Intertronics tells us that the eco-PEN 600 also maintains the

ease of use characteristic of the endless piston design with its easy clean rotor and stator, independence of feed pressure and easily controllable suck-back which ensures a clean material cut-off and no post-drip effects.

Associated microprocessor based controllers are available in bench top or panel-mount format and are claimed to be simple to operate, without submenus but with graphic support. A wide variety of dosing programs with part-management are storable. External signals can be connected by the preflow EC200's I/O ports to a PLC for control in automated lines.

INTERTRONICS 01865 842842



Richco

Design, manufacture and supply of plastic components

With many years of experience, customer focus and innovation we are able to help our customers in our core areas of design, manufacture and sales of plastic and metal fasteners.



3D

Visit our website today for full product details, order a catalogue or samples and download 3D models.

www.richco-int.com

Richco International Co Ltd Richco House, Springhead Enterprise Park, Springhead Rd, Gravesend, Kent DA11 8HE UK
tel: +(44) 1474 327527 fax: +(44) 1474 327455 email: sales@richco.co.uk web: www.richco-int.com



SpecialtyFasteners

UPDATE

ENGINEERED SOLUTIONS FOR THE 21st CENTURY

KEEP IT SIMPLE MAKE IT FAST



Camloc
Innovationally Innovative

**1/4 TURN
FASTENERS
FOR FAST &
FREQUENT
ACCESS**

Unlike conventional nuts and bolts, a quarter turn is all that is needed to open or close the joint, as the name would imply. From aviation to agriculture, motorsport to machine guards, they will find a use.



SPECIALTY FASTENERS & COMPONENTS LTD
Inches, Devon TQ9 4AJ
Tel: 01803 668677
Email: sales@specialty-fasteners.co.uk



SEE MORE SOLUTIONS TO YOUR FASTENING PROBLEMS AT
www.specialty-fasteners.co.uk

Clinch it..Tack it..Pierce it.. Punch it..Stick it..Align it.. Snap it on or off..

Fasten it your way with Böllhoff innovative fastener technology. Engineered to suit your application requirements.

- SNAPLOC® – reusable, high performance vibration-free, noise reduction fastening
- FLEXITOL® – stepless tolerance compensation fastener
- ONCERT® – ultra- fast light curing fastener bonding system
- RIVNUT® – blind rivet nuts
- RIVSET® – self-piercing rivets
- RIVTAC® – self-piercing blind fasteners
- RIVCLINCH® – metal clinching fasteners

BÖLLHOFF
Joining together!

Call us today for details.
01902 637161

Böllhoff Fastenings Ltd, Willenhall WV13 2JW
E-Mail: enquiries@bollhoff.com • www.bollhoff.com/uk

www.bollhoff.com/uk

FASTPRODUCTS

Rapid prototyping concept for fastening components

Arnold Umformtechnik has come up with rapid prototyping concept that allows highly complex fastener components and precision parts to be developed quickly as prototypes and manufactured later as production-ready parts with the same technical properties and cost-effectiveness for large volume production. Fastener Express, the company boasts, closes the gap between development and regular production.



Nowadays for new cars the elapsed time between the first sketch on the drawing board and the start of regular series production is little more than 30 months. Nearly half of the time previously required has been eliminated, thanks to the systematic optimisation of the entire supply chain for automobile production, which

has now reached the small-parts level as screws, bolts, turned parts and precision parts. In the past, development departments had to reckon on development times of up to 30 weeks for special solutions in this area.

As early as the development phase, Arnold's Fastener Express team carries out the Production Ready check to determine whether the subsequent production-ready part will be a turned part or a moulded part. This decision has major ramifications in terms of potential cost savings. Many turned parts can be converted to more economical moulded parts during the transition from the prototype phase to volume production.

With the Fastener Express method, a specially formed rapid prototyping team eliminates the lost time that usually arises from administrative processes. The established direct acceptance process systematically eliminates request delay times typical in the industry. Instead of a wait for handling, order receipt automatically triggers a prompt technical evaluation of factors such as using typical fastener materials or testing the mechanical properties of the joint.

ARNOLD UMFORMTECHNIK
+49 7947 821 170

Quick sign assembly with re-usable fastener

Sign Fastener is a new product from **Micro Plastics** which has been designed for rapid assembly and disassembly of a sign or other panel to its support structure. This reusable fastener fits hole diameters of 8mm to 9.5mm and



can be used to fasten two panels with a total thickness of between 25.4mm and 41.6mm by simply squeezing the keeper together and sliding onto the pin.

Moulded from impact resistant and UV stabilized nylon 6/6, the sign fastener is designed for weather in outdoor applications.

Micro Plastics manufactures millions of fasteners every day. The company offers over 20,000 items and maintains an inventory of over 250 million parts. Free samples are available on request.

MICRO PLASTICS 02476 614320

GESIPA

THE EXPERTS IN BLIND RIVETING SOLUTIONS

THE UK'S LARGEST SUPPLIER OF:

- COMPLETE SOLUTION SUPPLIERS
- BESPOKE PRODUCT CAPABILITIES
- GLOBAL MANUFACTURING FACILITIES
- EXTENSIVE RANGE OF RIVET & RIVET NUT BASED SOLUTIONS
- ISO 9001, TS 16949 & ISO 14001 APPROVED

GESIPA

The Experts in Blind Riveting

GESIPA Blind Riveting Systems Ltd
 Dalton Lane, Keighley
 West Yorkshire, BD21 4JU
 United Kingdom

Tel: +44 1535 212 200
 Fax: +44 1535 212 232
 Internet: www.gesipa.co.uk
 E-Mail: info@gesipa.co.uk

Manufacturers of rivets, rivet nuts, tools & bespoke rivet based solutions

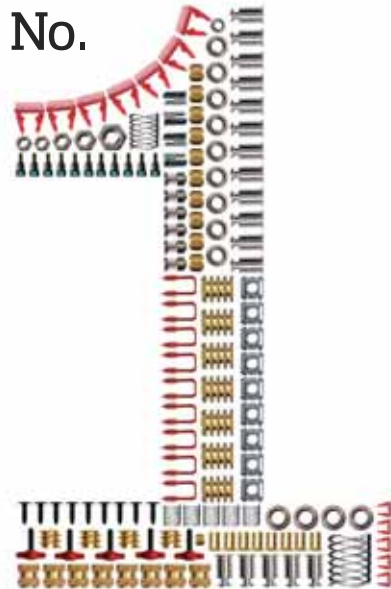

Complete Fastening Solutions

whatever your needs, we're number one

call now to speak to our expert team

+44 (0)1435 860333

www.fastenercentre.co.uk

COMPRESSION LATCHES

INTEGRATED HARDWARE

stainless steel
zinc diecast
fixed or adjustable compression
numerous head inserts
padlock options
vibration resistant
rated to ip65



Albert
Jagger
Limited

Industriál

WWW.ALBERT-JAGGER.CO.UK

Our word is your bond



Optically clear

Lohmann's Duplocoll® CPT (clear performance tape) has significantly improved the properties of acrylic adhesives.

How could it improve your project?



Solar

Lohmann Photovoltaic tapes have been specially developed for the energy industry.

Where could you use them?

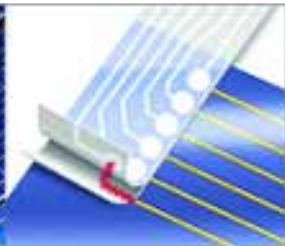

Electronics

Lohmann's unique ESD protection films have been specially developed for electronics applications.

What could they do for you?



Low Energy Surfaces

Lohmann's Duplocoll® 56000 LSE (low surface energy) is a specially developed pressure sensitive adhesive tape. It has been developed for applications involving very low surface energy.

Have you got Low Surface Energy? Lohmann can help!

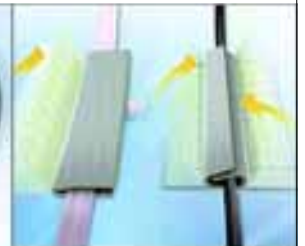

Automotive

Lohmann's Patented Duplocoll® CF technology adhesive tapes are ideal for a variety of clean, easy to apply precision cable fixings in vehicle, machine cabinets, furniture...

Where do you have cables that need managing - simply?

Lohmann Technologies UK Ltd,
25 Kelvin Drive, Knowlhill,
Milton Keynes MK5 8NH
Telephone: 01296 337 888
Email: info@lohmann-tapes.co.uk
Web: www.lohmann-tapes.co.uk

Lohmann
The Bonding Engineers.

FASTPRODUCTS

Flexible adhesive gains strength in less than an hour

Structural adhesives are generally available either as a fast curing solid structural material or as a slow curing product which can take up to 24 hours to reach its optimum bond strength. But now a new range of adhesives, formulated by AEC Polymers in France, combines both technologies to produce high strength adhesives which are also highly flexible. Three grades of SAF fast curing, flexible structural adhesives has been launched in the UK by Eurobond Adhesives.



Managing director Simon Dearing explained: "We have three different flexible grades 30%, 150% and 400% elongation which are available with three different cure speeds 15 minutes, 30 minutes and one hour. This depth in our range should be sufficient for any application.

This advanced new generation adhesive technology combines the high strength benefits of methacrylate structural adhesives with the flexibility of modified silyl (MS) polymer adhesives.

And is ideal when a user needs to bond two substrates that may be subjected to high flexing, vibration or thermal shocks and hasn't the time to wait 24 hours for an MS Polymer adhesive to cure. The SAF range will be widely used in automotive, marine, rail, general manufacturing, signmaking and construction industries and can tolerate powder coating processes after metal substrates have been bonded.

EUROBOND 01795 427888

Low profile compression latch aids environmental sealing

Two new stainless steel quarter-turn latches from Dirak offer compression in a low-profile design. The 7-078 fixed cam latch and 7-079 adjustable cam latch are claimed ideal for any indoor or outdoor application that requires compression for environmental sealing, reduction of noise and rattling due to vibration and low protrusion.

When using these latches, the door is locked and secured with a 180° turn. The first 90° turn secures the door closed. The second 90° turn compresses the gasket. There is a coloured locked and unlocked indicator on the face of the latches so the user can clearly see the lock status.

Both latches offer up to 6mm of compression and can be used with variable door thicknesses of 0.8mm to 22mm. They are water and dust-tight according to IP 65 and DIN EN 60529. Available in both left and right hand versions, interior protrusion of the latches in an uncompressed position is 48mm and 69mm respectively.

DIRAK 01252 333864



Quick access fastener turns heads

Ben Goater, Southco's Global Product Manager believes that Dzus Fasteners has taken the quarter-turn fastener to a new and unrivalled level of development with the introduction of the D8 three years ago. The product incorporates a manufacturing technology that uses a rolled cam form process exclusive to parent company Southco. This quick access fastener has seen sales increase by 28% overall, including 60% growth in the USA in the past year alone.

Goater explained: "The D8 range is a culmination of over 80 years' experience in quarter-turn fastener technology and manufacture designed to offer a far more effective alternative to the screw. [The product] came about because we recognised the limitations of traditionally machined fasteners and the many advantages – including improved quality, reliability and feel – that the



orientation of head feature to cam feature on a rolled fastener would bring to the quarter-turn quick access market.

The key features which make the D8 line a leading choice for a wide range of applications is its oriented head to cam feature. Other significant attributes include its precision fit, quick assembly, smooth feel and improved aesthetics, superior strength, improved ergonomics, and choice of stud sizes and receptacle styles.

SOUTHCO EUROPE 01905 346500

Spring latches suit arduous environments

The GN722 series of 180° operation spring latches have been released by Elesa for use in steel fabrications or assemblies where quick and low cost positioning or locking is required with a simple manual activation. The company tells us the latches have been specifically designed to function in arduous and dirty environments such as in the production of jigs and fixtures, in clamping devices and assembly installations, for locking, fixing and securing components and parts in dirty or messy work places such as those where dusty materials are involved. This would include production or service situations in industries such as shipbuilding, mining and agriculture.

The latch is operated by turning the thumb lever 180° to either retract or extend the indexing pin, location of the mechanism is ensured with an indexing notch for each position. Housings of



the Elesa GN722 are in zinc plated cast steel with black painted finish and are provided with mounting lugs for machine screw or nut and bolt fixing. However, the product is left in natural steel to facilitate welding in position as required.

ELESA 01526 322670

FASTPRODUCTS

No more sealing problems for flow control products

Ball valves, utilising a drilled-through ball rotating in a retaining socket, are widely used for process line control operations within industry. Ball valves offer both flow throttling and full shut-off conditions, while applications can involve an extensive range of pressures, temperatures and even the use of chemically aggressive fluids. The importance of specifying the right sealing products for use within these valves becomes paramount, particularly where breakdowns or plant shutdowns caused through valve failure can be catastrophic.

Specialist sealing company, **Dichtomatik**, solved a recent problem application involving a trunnion mounted ball valve used in the gas cleaning/sweetening processes. This involved the removal of carbon dioxide and acidic gasses such as hydrogen sulphide from gas streams, including synthesis gas produced by

the gasification of coal, coke and heavy hydrocarbon oils. Gas sweetening is commonly undertaken in refineries, petrochemical plants and gas processing facilities, where the process often utilises a glycol-based solvent for the acid gas removal.

The solvent chemistry, together with rapid gas decompression (RGD), can attack the valve seals and O-rings typically located in the valve seat. This can lead to seal life reduction, premature valve leaks and higher costs for both plant operation and maintenance.

A successful solution was achieved by the fitting of DuPont Kalrez Spectrum 7090 seals. These perfluoroelastomer products offer an excellent combination of chemical compatibility, with both RGD and high temperature resistance for O-ring applications, particularly where handling glycol-based solvents.

DICHTOMATIK 01332 524401



UV curable epoxy has enhanced chemical resistance

Combining superior physical strength and fast cure rates, **Master Bond UV16** is formulated for demanding bonding, sealing, and coating applications. It is a one component, no mix system and cures in one minute or less at room temperature with commercial UV light sources.

This 100% reactive epoxy is uninhibited by oxygen and does not release any solvents or volatiles during the curing process. UV16 will cure in thicknesses up to 0.125 inches and has a 2% to 3% shrinkage rate, which is substantially lower than most free radical UV adhesives. Once cured, it delivers a tensile strength exceeding 4,100 psi and a Shore

D hardness over 75. Post-curing UV16 at 90° to 125°C for 30 minutes gives the adhesive a glass transition temperature of 135°C and enhances its chemical resistance.

In a three month immersion test in 20% sulphuric acid, the material exhibited less than a 3% weight gain and UV16 had a weight gain of less than 2% when immersed in 90% isopropyl alcohol for the same amount of time. It has a viscosity of 200 to 400 cps and adheres well to a wide array of substrates, including plastics, glass, and many metals. A higher viscosity version called UV16TK is also available.

MASTER BOND +1 201 343 8983



Robust actuators suit entry door applications

Constructed of corrosion-resistant materials, two actuators from Southco are suitable for entry door solutions and harsh environments. The actuators are designed for applications in the off-highway, marine and transportation industries.

The **Southco AC-30** and **AC-40** actuators can work directly with the company's R4 rotary latches or be combined with cables or rods for a complete rotary latch system. A key-locking feature with multiple key codes ensures added security, and a lock/unlock indicators provides visual feedback on lock status.

The AC-30's single hole installation is useful where mounting space is restricted, while the AC-40 features a large grab handle and single-motion open feature. Both actuators work



wide a range of temperatures and deliver a great cycle life for years of reliable performance.

Product Manager Manan Patel commented: "With the availability of these two actuators, Southco is able to provide a complete rotary latch system for entry doors with cables, actuators and R4 rotary latches. They are constructed for reliable performance outdoors to ensure years of dependable performance."

SOUTHCO EUROPE 01905 346500

FASTPRODUCTS

K-Series Joins the TR Family

TR Fastenings is introducing a new K-Series nut and claims that it is the first nut that can be used for sheet steel and plastic applications too thin to be tapped by conventional methods.

The K-Series nut has been specially designed for use in applications with a minimum sheet thickness of 1mm. The nut, which offers a permanent female thread, can be installed without the need for specialist tooling. Once fixed, the product offers a permanent thread with a high prevailing torque and pull-out resistance.

K-Series nuts are manufactured in a case hardened carbon steel, plated and tested to ISO898, stainless steel can be supplied to order. Sizes range from M2.5-M16, with three different spigot lengths, the body of the product is hexagon with a serrated spigot.

The K-Series nut, which will be available in time for the

Fastener Fair Hannover from 24-26 April 2012.

TR FASTENINGS 01825 747200

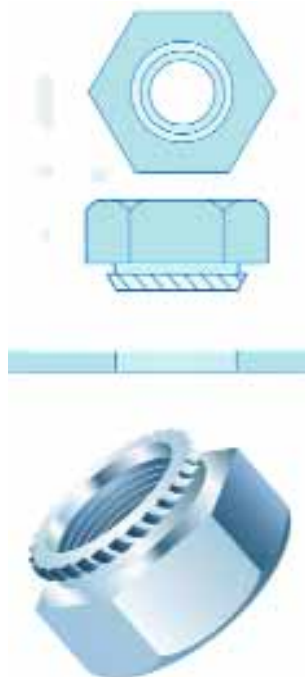

35 years of EJOT PT.

Revolutionising thermoplastics assembly since 1977.

The EJOT PT screw may have launched as flared trousers disappeared... but the PT revolution was far from over!

35 years later, the P I, Delta P I and Type DS fasteners, combined with DeltaCALC online prognosis, still represent the most advanced direct assembly into thermoplastics.

To talk to an EJOT Application Engineer call 01977 68 70 40
www.ejot.co.uk



You'll never over-tighten a screw again

An important development in torque tools has taken place with the launch of an innovative range of torque screwdrivers, claims torque measurement and control specialist Norbar.

The TruTorque range of products includes adjustable tools for flexibility of use and fixed torque versions called P Types, which have been designed for the production environment and pre-set for specific workplace demands.

Norbar tells us that the new products are

safe, easy-to-use and extraordinarily accurate, to better than the International Standard. They also offer high performance capabilities for dealing with a wide range of precision tasks requiring sensitive and safe screw connection, it is claimed. All adjustable tools are supplied with traceable calibration certificates.

The variable versions are easy to adjust without need of additional tools and can be locked to prevent accidental adjustment of the set torque. The durable handle is constructed from a strong base material covered with a soft overlay for comfort and slip resistance.

Norbar Torque Tools
01295 270333



SecuFast®



Most complete supplier of Security Fasteners

Tel: +31 15 3615210

Fax: +31 153615299

E-mail: mblaauw@douwes.nl

www.secufast.com

FASTTAILPIECE

Civilised hooks for modern times

A recent Sugatsune newsletter points out that in days gone by the guisarme was used to dismount riders and hurt them. This nasty medieval pole weapon was almost certainly invented by French peasants by sticking a bill hook on the end of a long stick. In today's slightly more civilised world, the fastener buyer can peruse a manufacturer's catalogue and see a vast range of hooks that could also be used to do mischief if you so choose. But after

a quick scan of the Sugatsune catalogue, for example, the buyer may find the JF-T, a swinging hook with friction, designed with enhanced safety.

A fixed hook in a locker room offers pointy metal at eye level. Not too much of a hazard in an adult Health Club with it's restrained atmosphere but in a school locker room things can be quite different. Boisterous behaviour could result in serious injury. And apart from the

health risks an immovable hook will snag and rip clothes more easily and in an industrial environment pose a greater risk to passing objects.

The JF-T hook swivels when it contacts a moving object but as it has a friction damper, it will stay where put. This feature can also be useful in the transport industry or where vibration is present. Sugatsune manufactures hooks for a diverse range of applications small and large including rotating and swing hooks, recessed hooks, clean room hooks and latch hooks. Some



Fortunately today's swinging hook offers enhanced safety

may think Sugatsunes' attention to detail obsessive but in reality it's just good design.

SUGATSUNE 01189 272 955

The guisarme could do some real damage to a French peasant



Service awards reflect 125 years' experience

Fran Tarantonio, financial controller (pictured in the centre) and Neil Fieldhouse, warehouse team leader (right) at Bollhoff UK have recently received 10 year service awards and join a group of fastener industry specialists whose combined experience at the Willenhall based firm amounts to 125 years.

Last November Gill Wright, sales team leader, celebrated 20 years with the company along with Andrew Gardner, UK sales manager

(pictured right), and Andy Witts, managing director, both of whom have been with the company for 10 years. Other members of the long serving team include Warren Webb, quality manager, 17 years; Matt Richmond, equipment specialist, 14 years; Tony Dutfield, general manager Bollhoff Direct, 13 years and Steve Pickersgill, technical services manager, 11 years.

Well done all of you!

BOLLHOFF 01902 637161



£100 CASH QUIZ!

Win a cheque for £100 from the publishers of FAST Magazine! Submit your answers by faxing this completed entry to us on 0845 280 1587 or emailing them to quiz@fastmagazine.co.uk with your name, job title, company name and contact number. A draw from all correctly answered entries will be made in the FAST Magazine office on 1st March and the winner notified by phone and email. The winner will also be announced in the next issue of FAST Magazine, published in April 2012.

- Of which world-class engineering business was Sir Stanley Hooker a director?
 - Supermarine Rolls-Royce BAC
- Clockmaker John Harrison designed timepieces that allowed mariners to accurately establish their longitude. Where was he born?
 - Kent Surrey Yorkshire
- British engineer Hubert Booth patented what in 1901?
 - Powered vacuum cleaner Electric cash register
 - Vinyl floor covering
- The UK's Henry Maudslay invented what?
 - The first viable screw and thread cutting machine
 - Carbonated drinks Metal aeroplane propellers
- When was the first prototype VW Beetle completed?
 - October 1935 January 1937 February 1939
- David D Buick founded the Buick brand of motor cars. Where was he born?
 - Detroit, Michigan Cleveland, Ohio Arbroath, Scotland

Last issue's winner was Roger Bentley, Design Engineer, Chubb Locks Custodial Services Ltd. Congratulations Roger! The correct answers were: 1. Matt Summers piloted the Spitfire on its maiden flight. 2. 900 revs for a top fuel dragster engine in a 4 second run. 3. The speed of sound is faster under water. 4. Sir Isaac Newton was born in Lincolnshire. 5. Jesse Owens was from Alabama. 6. Teflon was discovered in 1938. Our thanks to the many readers who entered.

FAST
FASTENING & ASSEMBLY SOLUTIONS AND TECHNOLOGY
exhibition

IASE
INDUSTRIAL ADHESIVES, SEALANTS & ENCAPSULANTS
exhibition

NORTH

Visit the UK's only dedicated fastening and adhesives exhibitions. Discover the latest advances, innovations, ideas and products for industrial and engineering fastening, bonding and sealing. Meet and talk with some of the best suppliers in the business!

PAVILIONS OF HARROGATE

Great Yorkshire Showground HG2 8NZ

Thursday 26th April 2012

8.30am – 2pm

Pre-register at

www.fastenerexhibition.com

Free bacon bap and
brew on arrival for
pre-registered visitors





MACHINE SCREWS - Over 3300 Sizes



UNIVERSAL NUTS - Over 150 Sizes



PANEL FASTENERS - Over 650 Sizes



P.C.B. HARDWARE - Over 300 Items



HOSE CLAMPS - 3 Styles - 38 Sizes



HOLE PLUGS - 7 Styles - 85 Sizes



SPACERS - 7 Styles - 1300 Sizes



WIRE HANDLING - Over 500 Items



WASHERS - 8 Styles - 2000 Sizes

www.microplastics.co.uk